



GUERCIOTTI

THE BRIGHTEST STAR IN MILAN



LA STELLA PIÙ LUMINOSA DI MILANO.

Più di cinquant'anni di storia, ma la voglia è quella di guardare ai prossimi cinquanta: ecco la filosofia con cui Guerciotti si affaccia al futuro.

Nuova stagione, nuove bici. Il nostro brand prosegue il suo percorso di rinnovamento pensato per imprimere sempre di più la stella di Guerciotti nell'immaginario collettivo dei ciclisti più esigenti.

Da più di cinquant'anni l'esperienza e la nostra capacità tecnica unite alla grande tradizione racing, fanno del marchio Guerciotti un sigillo di qualità. Appreziate in tutto il mondo, le nostre biciclette sono state il segreto del successo per numerosi campioni come Michele Scarponi, Davide Rebellin e Gilberto Simoni. Su strada come nella disciplina del ciclocross, formiamo da sempre i campioni di domani. Tutto questo fa parte del nostro mondo, che raccontiamo con l'orgoglio di chi fa le cose per bene.

Tutto questo è Guerciotti:
la stella più luminosa di Milano.

THE BRIGHTEST STAR IN MILAN.

More than fifty years of history, but the desire is to look at the next fifty: here is the philosophy with which Guerciotti faces the future.

New season, new bikes. Our brand continues its path of renewal, conceived to imprint day by day the star of Guerciotti in the collective imagination of the most demanding cyclists.

For over fifty years the experience and our technical ability combined with the great racing tradition, make the Guerciotti brand a seal of quality. Appreciated all over the world, our bicycles have been the secret of success for numerous champions such as Michele Scarponi, Davide Rebellin and Gilberto Simoni. Both on the road and in the discipline of cyclocross, we have always trained the champions of tomorrow. All this is part of our world, which we communicate with the pride of those who make things better.

All this is Guerciotti:
the brightest star in Milan.

THE BRIGHTEST STAR IN MILAN





X-RAYS TECH

Tecnologia ai raggi X

LE NOVITÀ GUERCIOTTI VISTE DA VICINO.

La sfida del mercato è quella di produrre biciclette sempre più tecnologicamente avanzate: oggi questo significa integrazione dei cavi nel telaio e miglioramento del sistema frenante.

È per questo motivo che Guerciotti ha lavorato per regalare agli appassionati una linea di prodotti innovativi, dalla linea estetica contemporanea e caratterizzati da una pulizia di fondo della componentistica.

Da questo punto di vista spiccano i due manubri integrati di Eureka Air Disc (ALL IN) e di Eclipse S Disc.

ANDIAMO "ALL IN"

ALL IN è un sistema brevettato che consente la totale integrazione di tutti i passaggi cavo all'interno del manubrio in carbonio e dell'attacco manubrio realizzato in alluminio forgiato.

A CLOSE UP OF GUERCIOTTI NOVELTIES.

The challenge of the market is to produce more and more technologically advanced bicycles: today this means integrating the cables in the frame and improving the braking system.

This is why Guerciotti has worked to give fans a line of innovative products, with a contemporary aesthetic line and characterized by a thorough cleaning of the components.

From this point of view the two integrated dumbbells of Eureka Air Disc (ALL IN) and Eclipse S Disc stand out.

LET'S GO "ALL IN"

ALL IN is a patented system that allows the total integration of all the cable routings inside the carbon handlebar and the stem made of forged aluminum.

NEW "ALL IN" COCKPIT

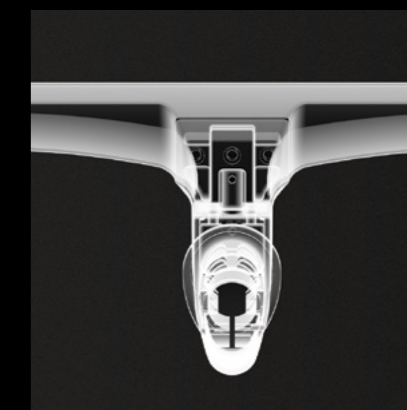
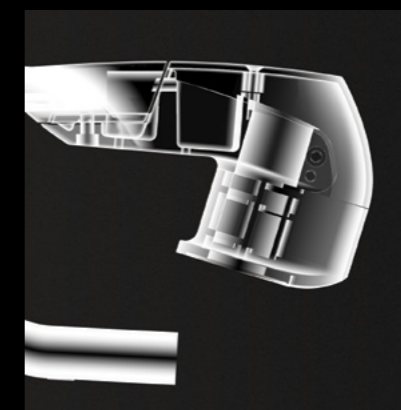
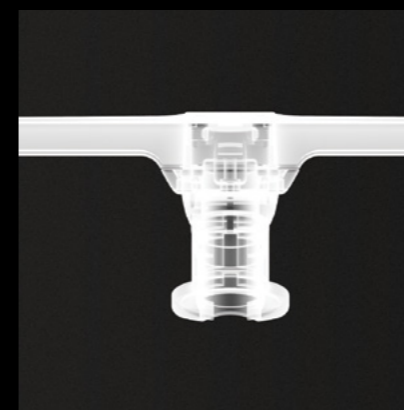
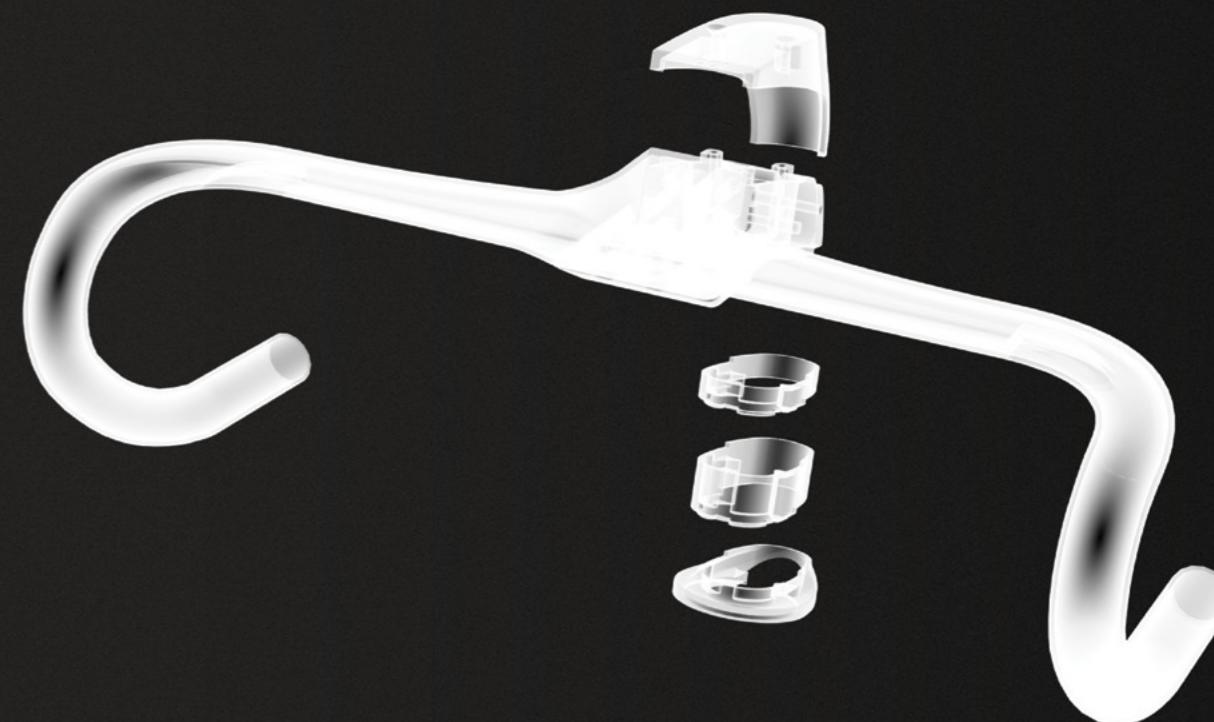

Design e funzione grazie al passaggio cavi interno.

Il sistema consente, a montaggio completo della bicicletta, la sostituzione dell'attacco manubrio con un attacco di lunghezza diversa. Questa operazione avviene senza dover necessariamente rilasciare nessun cavo già assemblato.

Design and function thanks to internal cable routing.

The system allows, when the bicycle is mounted completely, to replace the stem with a different length of stem. This operation takes place without necessarily having to release any already assembled cable.



COMPLETE CABLE INTEGRATION

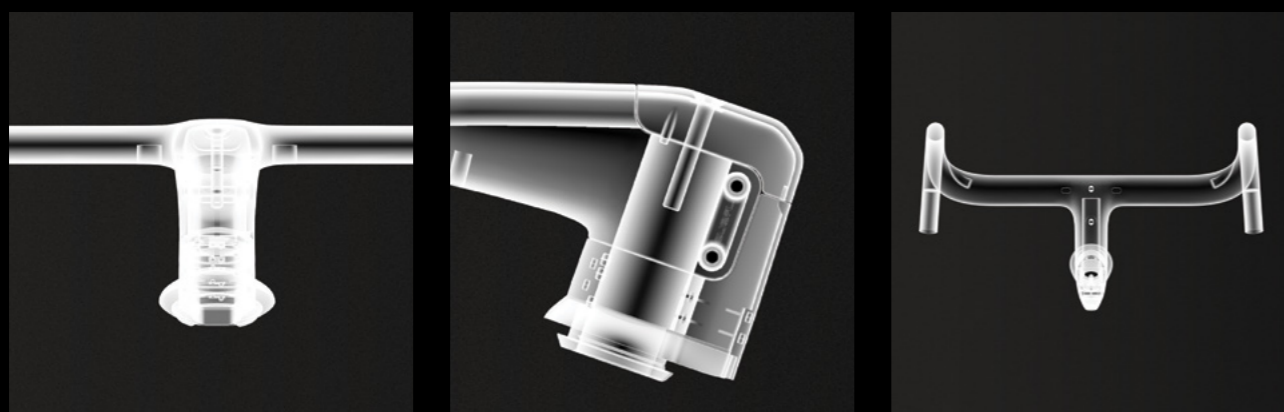
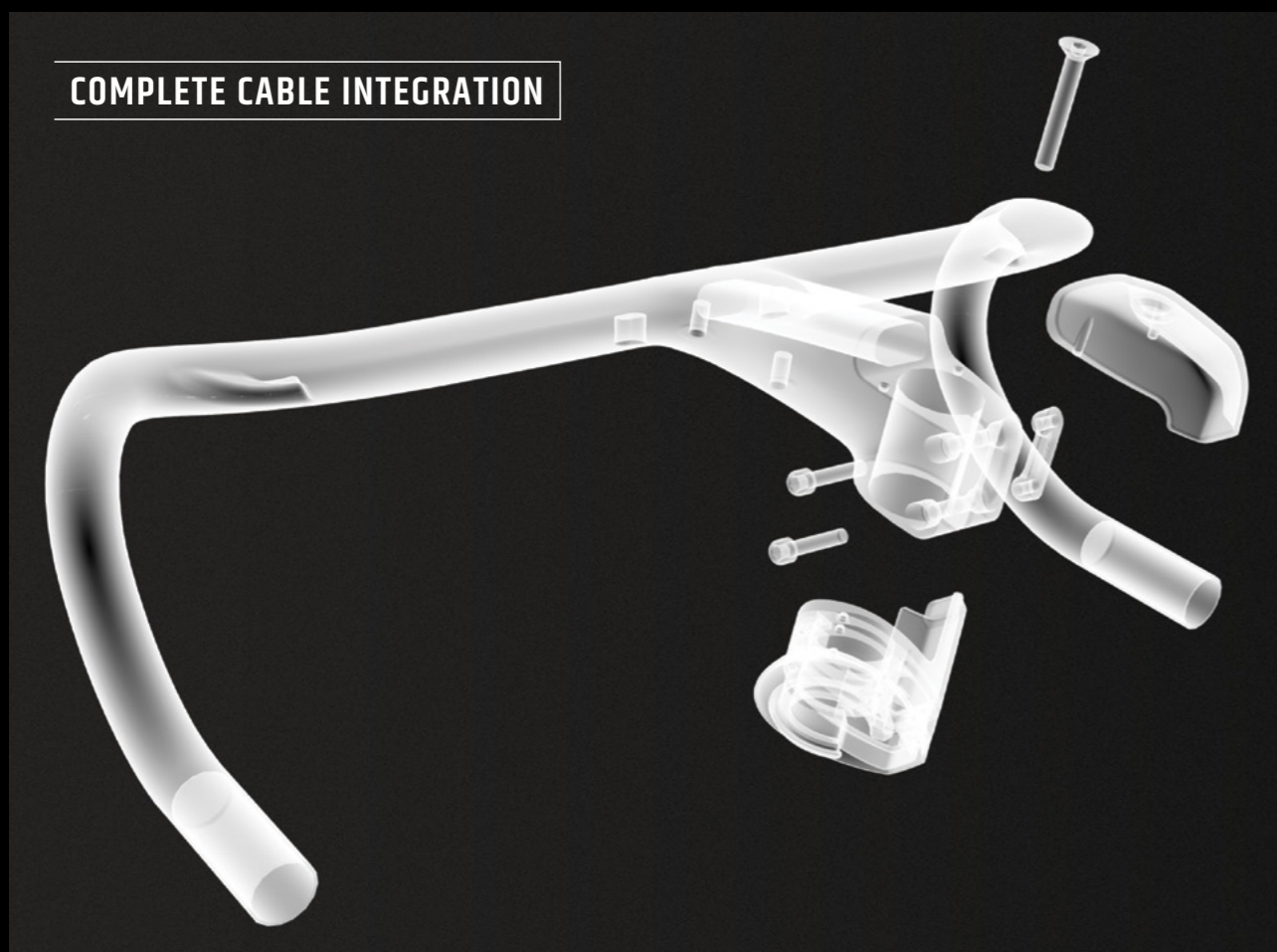

Tecnicità ed estetica in una serie sterzo da urlo.

L'esclusivo manubrio integrato Guerciotti è completamente realizzato in carbonio. Tramite il sistema ACR che unisce serie sterzo e manubrio possiamo avere una perfetta integrazione dei cavi, estesa anche alla forcella. Infatti questa serie sterzo è proposta in kit con il telaio Eclipse S Disc. Design lineare e pulito.

Technicity and aesthetics in a stunning head set.

The exclusive Guerciotti integrated handlebar is completely made of carbon. Through the ACR system that combines the headset and handlebar we can have a perfect integration of the cables, extended also to the fork. In fact this headset is available as a kit with the Eclipse S Disc frame. Linear and clean design.

DISC BRAKES ON MORE BIKES



Freni a disco, per una frenata millimetrica.

Guerciotti amplia l'offerta di bici con freno a disco destinate al mondo corsa. Di derivazione ciclocross, la soluzione disco Guerciotti permette di offrire una precisione di frenata millimetrica con la massima affidabilità.

Millimetric disc braking precision.

Guerciotti expands its offer of disc brake bikes for the racing world. Derived from cyclocross, the Guerciotti disc solution allows us to offer millimetric braking precision with maximum reliability.



MADE IN MILANO

discover our cromovelato paintjob

EUREKA AIR DISC LIMITED EDITION #madeinmilano

Campagnolo Super Record
12v EPS disc



Una verniciatura di pregio.

In onore della città di Milano,
ti presentiamo la nuova limited
edition #MadeInMilano,
riconoscibile dalla sua iconica
verniciatura.

Da oggi è ufficialmente disponibile al
grande pubblico la mini collezione in
edizione speciale ispirata alla nostra
città natale. La limited edition dei
gioielli #MadeInMilano si fa notare in
prima battuta grazie alla esclusiva veste
grafica: Guerciotti punta infatti su un
rosso "emozionale" ispirato alla città
meneghina, patria del Design e del buon
gusto italiano. Realizzata combinando
effetto cromovelato e satinato, questa
finitura di pregio veste con classe una
serie di prodotti completamente votati
all'innovazione.

A prestigious painting.

Introducing the new
#MadeInMilano limited edition,
recognizable for the iconic
paintjob, tribute to the city
of Milan.

This capsule collection is inspired from
our hometown, and it is now officially
available for every ambitious cyclist.
The limited edition of this #MadeInMilano
jewels stand out in the first place due to
a renewed look: Guerciotti has chosen
an "emotional" red which was inspired
by the city of Milan, homeland of Italian
design and taste. Created by combining
the "cromovelato" with a satin effect, this
fine finish completes a classy series of
products, fully devoted to innovation.

ECLIPSE S DISC LIMITED EDITION #madeinmilano

Shimano
Dura-ace 9170
disc di2 11v



E740 DISC LIMITED EDITION #madeinmilano

Campagnolo
Super Record
EPS 12v disc



EUREKA AIR LIMITED EDITION #madeinmilano

Shimano
Dura-ace
9150 Di2 11v



E740 LIMITED EDITION #madeinmilano

Campagnolo
Super Record
12V



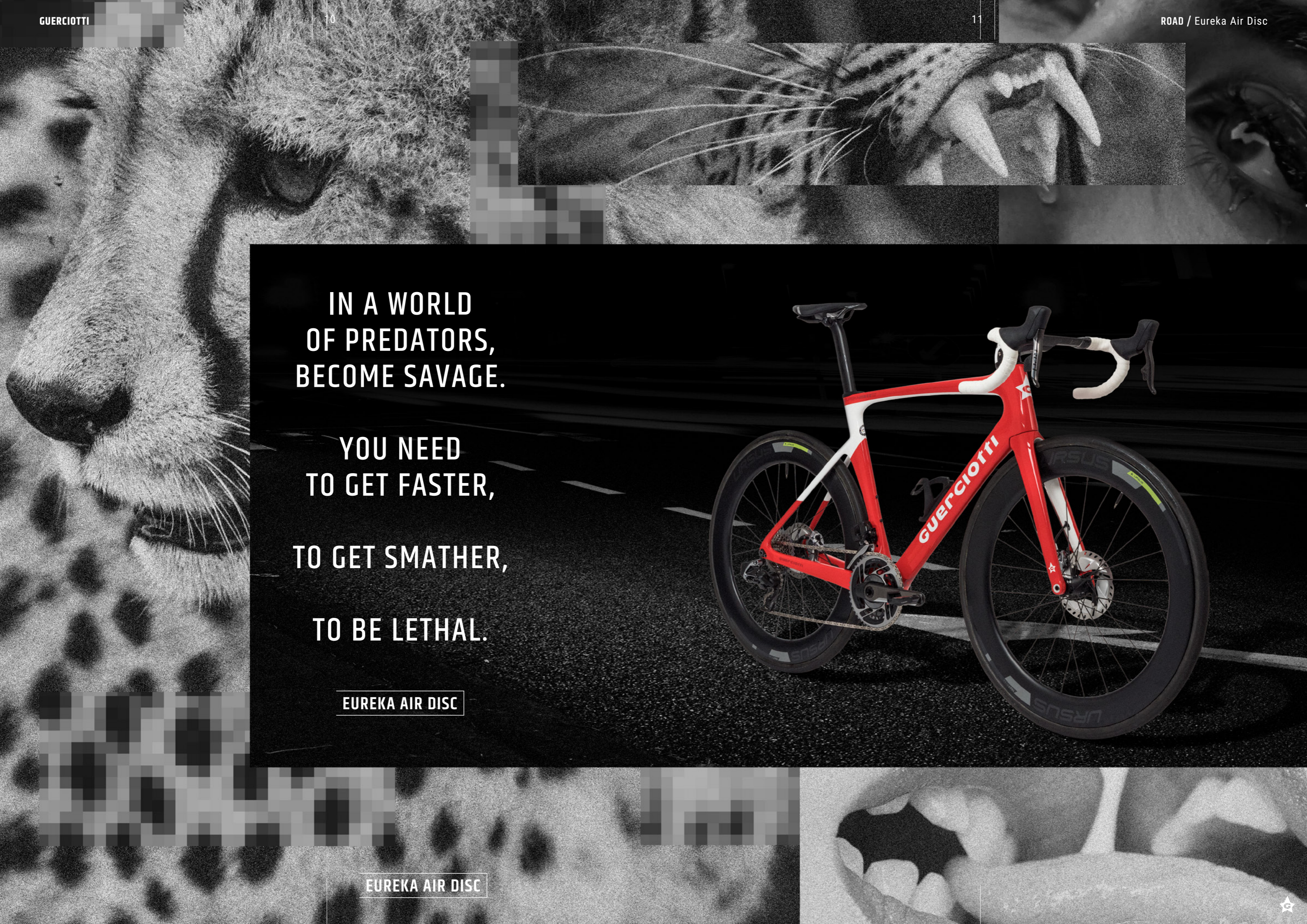

IN A WORLD
OF PREDATORS,
BECOME SAVAGE.

YOU NEED
TO GET FASTER,
TO GET SMATHER,
TO BE LETHAL.

EUREKA AIR DISC



EUREKA AIR DISC





Meraviglia Tecnica.

Una profonda storia racing come la nostra deve essere onorata, ecco perché Guerciotti ha creato Eureka Air Disc: la nostra meraviglia tecnica, il nostro capolavoro. Lasciati impressionare dalla pulizia delle linee, dall'assoluta assenza di cavi a vista. Grazie all'esclusivo manubrio ALL IN puoi contare su un design di altissima gamma.

A technical wonder.

A deep racing history like ours deserves to be honoured. That's why Guerciotti created Eureka Air Disc: our technical wonder, our masterpiece. Get impressed by the new clean shape, by the absence of external cables. The exclusive ALL IN handlebar completes this high end design.

TELAIO MONOSCOCCA PIÙ LEGGERO

Telaio monoscocca realizzato in stampata unica (incluse le vie interne) per un controllo della distensione dei vari strati di carbonio e una bici ancora più leggera. Per la realizzazione di Eureka Air Disc viene utilizzata solo fibra di alta qualità.

LIGHTER MONOCOQUE FRAME

Monocoque frameset made in one single piece in molded print (including internal ways) for a control of the relaxation of the various layers of carbon and an even lighter bike. Only high quality carbon fiber is used for Eureka Air Disc.



FORCELLA

L'assoluta novità di Eureka Air Disc è la forcella con cavi completamente a scomparsa. Studiata assieme al manubrio ALL IN, questa forcella dona areodinamicità totale ed estetica perfetta alla bici.

FORK

The absolute novelty of Eureka Air Disc is the fork with completely retractable cables. Designed together with the ALL IN handlebar, this fork gives total aerodynamics and perfect aesthetics to the bike.

MOZZO POSTERIORE

Per ottenere un connubio telaio-ruote estremamente rigido, Eureka Air Disc utilizza mozzi con perno passante. Le pinze flat mount garantiscono invece un sistema di frenata di ultima generazione.

REAR HUB

Eureka Air Disc is equipped with Thru Axle hubs: this allow to obtain an extremely rigid interaction between frame and wheels. The flat mount provides a next-generation braking system.

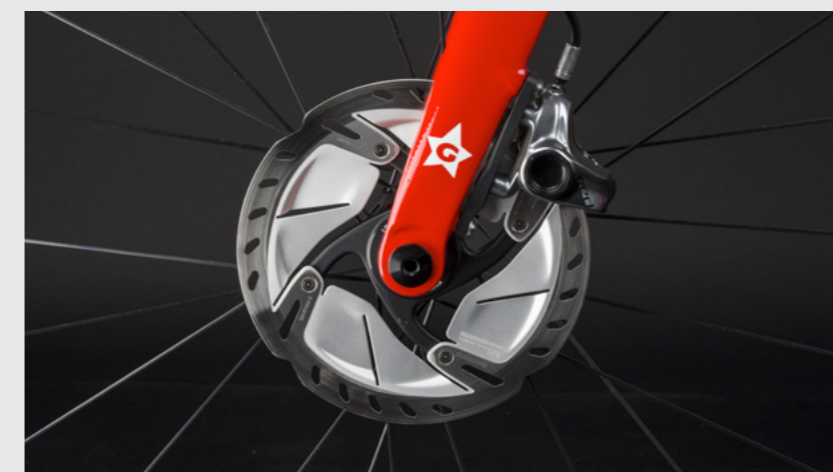

FRENI A DISCO

La soluzione freno a disco permette di frenare in assoluta sicurezza. I cavi idraulici sono completamente integrati all'interno del telaio, per la massima areodinamicità della bici.

DISC BRAKES

The disc brakes allow a perfectly safe braking experience. The hydraulic cables are fully integrated within the frameset, this gives the bike a maximum aerodynamic performance.

ATTACCO MANUBRIO

Areodinamicità, sicurezza ed eleganza della bicicletta sono assicurati anche dal suo speciale attacco ALL IN: un sistema di passaggio cavi completamente interno è stato studiato per eliminare qualsiasi problema in zona sterzo.

STEM

Aerodynamic, safety and elegance of the bike are ensured by its special ALL IN handlebar: we studied a internal cable routing system which eliminates any eventual issue in the steering zone.





EUREKA AIR DISC

Campagnolo

Super Record 12 V EPS Disc

Esteticamente bella,
tecnicamente perfetta.

Eureka Air Disc in edizione speciale non si ferma all'apparenza:

Guerciotti ha deciso di fare un grande regalo agli appassionati proponendo questo modello con montaggio Super Record 12V EPS Disc, gruppo di altissima gamma firmato Campagnolo.

Questa meraviglia tecnica proposta dall'azienda di Vicenza si fonde perfettamente con i dettagli aerodinamici del telaio Eureka Air Disc esaltandone la propensione altamente racing, l'ergonomia e migliorando ulteriormente un già di per se ottimo indice di controllo. Guerciotti consegna perciò al mercato un prodotto dalle prestazioni uniche in termini di precisione di guida, fluidità del cambio, maneggevolezza e qualità della frenata.

Aesthetically beautiful,
technically perfect.

Eureka Air Disc special edition is more than just beautiful:

The new Eureka Air is more than just beautiful: Guerciotti has decided to make a great gift to the fans by proposing this model with Campagnolo Super Record 12V EPS Disc assembly.

This technical wonder proposed by the company based in Vicenza blends perfectly with the aerodynamic details of the Eureka Air frame, enhancing its racing propensity, ergonomics and further improving an already excellent index of control. Guerciotti therefore delivers to the market a product with unique performance in terms of driving precision, fluidity of the gear, maneuverability and braking quality.

THE BRIGHTEST STAR IN MILAN

Code
**EUREKA AIR DISC
LIMITED EDITION**
#madeinmilano

Campagnolo Super Record
12v EPS disc

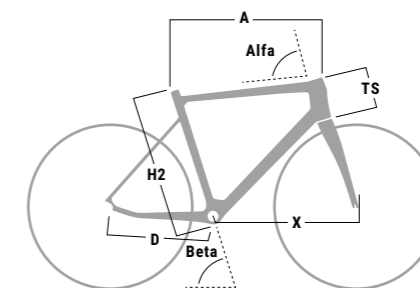

Misure	H2	A	X	D	TS	Beta	Alfa
GEOMETRIE SLOPING TELAIO EUREKA AIR DISC							
XXS	430	505	570,4	410	95	75°	71°
XS	470	515	574	410	105	75°	72°
S	490	536	575	410	120	74°	73°
M	510	547	580	410	140	73,5°	73°
L	530	565	593	410	160	73,25°	73,5°
XL	550	582	607	410	190	73°	73,5°



PESO TELAIO / FRAME WEIGHT : Kg 1,130

FORCELLA / FORK : Monocoque

SERIE STERZO / AHEADSET : a spessore differenziati / oversize 1-1/8 - 1-1/2

SCATOLA MOVIMENTO / BB SHELL : Pressfit

THRU AXLE / PERNI PASSANTI

FLAT MOUNT

REGGISELLA / SEAT POST : Eureka Air

LIMITE DI PESO / WEIGHT LIMIT : Kg 110

PREDISPOSTO PER / PREPARED FOR : gruppi elettronici / electronic groups

TELAIO INCLUSO DI ATTACCO E MANUBRIO / FRAMESET INCLUDED OF STEM AND HANDLEBAR

GRUPPO / GROUPSET	PEDALI / PEDALS	SELLA / SADDLE	REGGISELLA / SEAT POST	ATTACCO / STEM
Campagnolo Super Record 12v EPS disc	Look Keo Blade	Selle Italia SP-01 Boost	TEC for Eureka Air	Tec ALL IN for Eureka Air
CURVA / HANDLEBAR	RUOTE / WHEELS	COPERTURE / TIRES	P/BORRACCIA / BOTTLE CAGE	
Tec ALL IN for Eureka Air	Dedaelementi SL45 cop	Coperture Michelin power competition	Elite	



Code

AID01

Shimano Dura-ace 9170 disc di2 11v



GRUPPO / GROUPSET	PEDALI / PEDALS	SELLA / SADDLE	REGGISSELLA / SEAT POST	ATTACCO / STEM
Shimano Dura-ace 9170 disc di2 11v	Look Keo Blade	Selle Italia SP-01 Boost	Tec for Eureka Air	Tec ALL IN for Eureka Air
CURVA / HANDLEBAR	RUOTE / WHEELS	COPERTURE / TIRES	P/BORRACCIA / BOTTLE CAGE	
Tec ALL IN for Eureka Air	Dedaelementi SL45 cop	Coper. Michelin power comp	Elite	

Code

AID02

Shimano Ultegra 8070 disc di2 11v



GRUPPO / GROUPSET	PEDALI / PEDALS	SELLA / SADDLE	REGGISSELLA / SEAT POST	ATTACCO / STEM
Shimano Ultegra 8070 disc di2 11v	Look Keo Blade	Selle Italia SP-01 Boost	Tec for Eureka Air	Tec ALL IN for Eureka Air
CURVA / HANDLEBAR	RUOTE / WHEELS	COPERTURE / TIRES	P/BORRACCIA / BOTTLE CAGE	
Tec ALL IN for Eureka Air	Dedaelementi SL45 cop	Copert. Michelin power comp.	Elite	

Code

AID03

Sram Red E-tap AXS Disc 12v



GRUPPO / GROUPSET	PEDALI / PEDALS	SELLA / SADDLE	REGGISSELLA / SEAT POST	ATTACCO / STEM
Sram Red E-tap AXS disc 12v	Look Keo Blade	Selle Italia SP-01 Boost	Tec for Eureka Air	Tec ALL IN for Eureka Air
CURVA / HANDLEBAR	RUOTE / WHEELS	COPERTURE / TIRES	P/BORRACCIA / BOTTLE CAGE	
Tec ALL IN for Eureka Air	Ursus Miura TR67 Evo disc	Tubolari Michelin pro 4	Elite	

Code

AID04

Shimano Dura-ace 9120 disc 11v



GRUPPO / GROUPSET	PEDALI / PEDALS	SELLA / SADDLE	REGGISSELLA / SEAT POST	ATTACCO / STEM
Shimano Dura-ace 9120 disc 11v	Look Keo Blade	Selle Italia SP-01 Boost	Tec for Eureka Air	Tec ALL IN for Eureka Air
CURVA / HANDLEBAR	RUOTE / WHEELS	COPERTURE / TIRES	P/BORRACCIA / BOTTLE CAGE	
Tec ALL IN for Eureka Air	Ursus Miura TS47 Evo disc	Tubolari Michelin pro 4	Elite	



ECLIPSE S DISC

Evolution and design.





Evoluzione e design.

La famiglia di prodotti Eclipse ritorna con Eclipse S Disc, un telaio disco pensato per risultare estremamente leggero. Cavi integrati all'interno di telaio e manubrio, tubo sella innovativo con design profilato a pinna, freni a disco con perno passante compatibili per speed release. Non potrai fare a meno di innamorarti di lei.

Evolution and design.

The Eclipse product family returns with the Eclipse S Disc, a disc brake frame conceived to be extremely lightweight. Integrated cables inside frame and handlebar, innovative seat tube with fin-shaped design, disc brakes with speed release thru axle. You can't help but fall in love with her.

TELAIO MONOSCOCCA PIÙ LEGGERO

Telaio monoscocca realizzato in stampata unica incluse le vie interne, per un controllo della distensione dei vari strati di carbonio. Per la realizzazione di Eclipse S Disc viene utilizzata solo fibra di alta qualità.

LIGHTER MONOCOQUE FRAME

Monocoque frameset made in one single piece in molded print, including internal ways, produced with full EPS (Expanded Polypropilene System) technology for a control of the relaxation of the various layers of carbon. Only high quality carbon fiber is used for Eclipse S Disc.



FORCELLA

L'assoluta novità di Eclipse S Disc è la forcella con cavi completamente a scomparsa. Studiata assieme al manubrio integrato, questa forcella dona aerodinamicità totale ed estetica perfetta alla bici.

FORK

The absolute novelty of Eclipse S Disc is the fork with completely retractable cables. Designed together with the integrated handlebar, this fork gives total aerodynamics and perfect aesthetics to the bike.

MOZZO POSTERIORE

Per ottenere un connubio telaio-ruote estremamente rigido, Eclipse S Disc utilizza mozzi con perno passante compatibile per il sistema Mavic Speed Release. Le pinze flat mount garantiscono invece un sistema di frenata di ultima generazione.

REAR HUB

Eclipse S Disc is equipped with Thru Axle Speed Release hubs: this allow to obtain an extremely rigid interaction between frame and wheels. The flat mount provides a next-generation braking system.



FRENI A DISCO

La soluzione freno a disco permette di frenare in assoluta sicurezza. I cavi idraulici sono completamente integrati all'interno del telaio.

DISC BRAKES

The disc brakes allow a perfectly safe braking experience. The hydraulic cables are fully integrated within the frameset.

MANUBRIO INTEGRATO FULL CARBON

L'esclusivo manubrio integrato Guerciotti è completamente realizzato in carbonio. Tramite il sistema ACR che unisce serie sterzo e manubrio possiamo avere una perfetta integrazione dei cavi, estesa anche alla forcella. Infatti questa serie sterzo è ò proposto in kit con il telaio Eclipse S Disc. Design lineare e pulito.

INTEGRATED FULL CARBON HANDLEBAR

The exclusive Guerciotti integrated handlebar is completely made of carbon. Through the ACR system that combines the headset and handlebar we can have a perfect integration of the cables, extended also to the fork. In fact this headset is available as a kit with the Eclipse S Disc frame. Linear and clean design.



Code
ECLIPSE S DISC
LIMITED EDITION
 #madeinmilano

Shimano Dura-ace 9170
 disc di2 11v

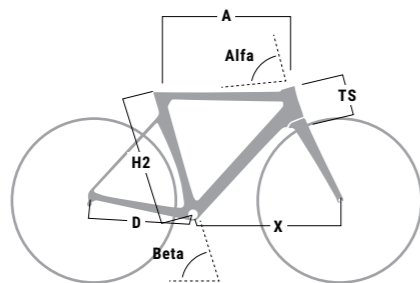

Misure	H2	A	X	D	TS	Beta	Alfa
GEOMETRIE SLOPING TELAIO ECLIPSE S DISC							
XXS	470	510	576,6	410	110	74,5°	70,5°
XS	490	520	583	410	120	74,5°	71°
S	520	535,2	584,7	410	130	74°	72°
M	540	550	591,5	410	150	73,6°	72,5°
L	560	565	598,7	410	170	73,3°	73°
XL	580	580	607,4	410	190	73°	73,3°



- PESO TELAIO / FRAME WEIGHT :** Kg 0,920
- FORCELLA / FORK :** Monocoque
- SERIE STERZO / AHEADSET :** a spessore differenziati / oversize 1-1/8 - 1-1/2 ACR system
- SCATOLA MOVIMENTO / BB SHELL :** Pressfit
- THRU AXLE / PERNI PASSANTI :** compatible for Mavic Speed Release
- FLAT MOUNT**
- REGGISSELLA / SEAT POST :** Eclipse S
- LIMITE DI PESO / WEIGHT LIMIT :** Kg 100
- PREDISPOSTO PER / PREPARED FOR :** gruppi elettronici / electronic groups
- TELAIO INCLUSO DI MANUBRIO IN CARBONIO INTEGRATO ECLIPSE S /**
- FRAMESET INCLUDED OF INTEGRATED CARBON HANDLEBAR ECLIPSE S**

GRUPPO / GROUPSET	PEDALI / PEDALS	SELLA / SADDLE	REGGISSELLA / SEAT POST	MANUBRIO INTEGRATO / INTEGRATED HANDLEBAR
Shimano Dura-ace 9170 disc di2 11v	Look Keo Blade	Selle Italia SLR	Eclipse S	Eclipse S
CURVA / HANDLEBAR	RUOTE / WHEELS	COPERTURE / TIRES	P/BORRACCIA / BOTTLE CAGE	
*****	Ursus Miura TS37 evo disc	Tubolari Vittoria corsa graphene	Elite	

Code
ES01

Sram Red E-tap AXS
 disc 12v



GRUPPO / GROUPSET	PEDALI / PEDALS	SELLA / SADDLE	REGGISSELLA / SEAT POST	MANUBRIO INTEGRATO / INTEGRATED HANDLEBAR
Sram Red E-tap AXS disc 12v	Look Keo Blade	Selle Italia SLR	Eclipse S	Eclipse S
CURVA / HANDLEBAR	RUOTE / WHEELS	COPERTURE / TIRES	P/BORRACCIA / BOTTLE CAGE	
*****	Dedaelementi SL30 disc	Coperture Vittoria corsa Graphene	Elite	

Code
ES02

Shimano Ultegra 8070 disc
 Di2 11v



GRUPPO / GROUPSET	PEDALI / PEDALS	SELLA / SADDLE	REGGISSELLA / SEAT POST	MANUBRIO INTEGRATO / INTEGRATED HANDLEBAR
Shimano Ultegra 8070 disc Di2 11v	Look Keo Blade	Selle Italia SLR	Eclipse S	Eclipse S
CURVA / HANDLEBAR	RUOTE / WHEELS	COPERTURE / TIRES	P/BORRACCIA / BOTTLE CAGE	
*****	Ursus Miura TS37 evo disc	Tubolari Vittoria corsa graphene	Elite	





E740 DISC

Let's climb together





Saliamo insieme.

E740 Disc è uno dei telai da corsa per freno a disco più leggeri sul mercato, con un peso vicino ai record mondiali. E740 Disc è l'arma perfetta per le salite più dure.

Questo telaio estremamente rigido è realizzato con un'unica stampata di carbonio per garantire estrema leggerezza della struttura senza risparmiare in affidabilità: E740 Disc può infatti trasportare un grosso carico in sicurezza. Da oggi anche un ciclista XXL ha la possibilità di pedalare con una super-leggera.

Let's climb together.

E740 Disc is one of the lightest road racing frameset on the market, with a weight close to the world record. E740 Disc is a perfect weapon for the most difficult climbs.

This stiff frame is printed with a unique mould to guarantee extreme lightness without saving in reliability: E740 Disc can indeed carry heavy weights safely, so today even an oversize cyclist has the chance to ride a super-light bike.



TELAIO MONOSCOCCA PIÙ LEGGERO

E740 è un telaio monoscocca, realizzato in un solo pezzo in stampata unica grazie alla tecnologia Full EPS. Questo sistema permette di ottenere un telaio più leggero, ma nello stesso momento più resistente a più elevati carichi di peso.

LIGHTER MONOCOQUE FRAME

E740 is a monocoque frameset made in one single piece in molded print, thanks to the Full EPS technology. This system permits to get a lighter frameset, but in the same time a more resistance frameset to higher loads of weights.

DESIGN DI CLASSE

Telaio esteticamente pulito, con un design che porta anche dei benefici a livello di peso complessivo ridotto.

CLASS AND DESIGN

Clean frameset shaping. Its design brings also benefits to the total bikes's weight.



FRENI A DISCO

La soluzione freno a disco permette di frenare in assoluta sicurezza. Questa è una novità assoluta di Guerciotti per il telaio di E740 Disc, mantenuto comunque molto leggero.

DISC BRAKES

The disc brakes allow a perfectly safe braking experience. This is a big news by Guerciotti for the E740 Disc frame, very lightweight.

POSTERIORI VERTICALI

Posteriori verticali con sezioni più sottili rispetto a precedenti modelli in modo da ridurre il peso ulteriormente, ma senza andare a discapito della rigidità.

REAR STAYS

Rear stays with thinnest profiles respect to the others models in order to reduce further the weight, but without reducing the stiffness.



Code
E740 DISC
LIMITED EDITION
 #madeinmilano

Campagnolo Super Record EPS
 12v disc

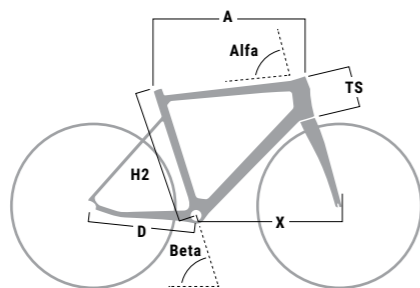

Misure	H2	A	X	D	TS	Beta	Alfa
GEOMETRIE SLOPING TELAIO E740 DISC							
XXS	450	505	571	405	105	75°	71°
XS	480	520	578	405	120	74,5°	71,5°
S	510	540	580	405	135	73,5°	72,5°
M	540	555	590	405	150	73,5°	73°
L	570	570	600	405	170	73°	73°
XL	600	590	609	405	190	72,50°	73,5°



- PESO TELAIO / FRAME WEIGHT :** Kg 0,840
- FORCELLA / FORK :** Monocoque
- SERIE STERZO / AHEADSET :** a spessore differenziati / oversize 1-1/8 - 1-1/2
- SCATOLA MOVIMENTO / BB SHELL :** Pressfit
- THRU AXLE / PERNI PASSANTI**
- FLAT MOUNT**
- REGGISSELLA / SEAT POST :** 27.2
- LIMITE DI PESO / WEIGHT LIMIT :** Kg 90
- PREDISPOSTO PER / PREPARED FOR :** gruppi elettronici / electronic groups

GRUPPO / GROUPSET	PEDALI / PEDALS	SELLA / SADDLE	REGGISSELLA / SEAT POST	ATTACCO / STEM
Campagnolo Super Record EPS 12v disc	Look Keo Blade	Selle Italia SP-01 Boost	Dedaelementi Superleggero	Dedaelementi Super zero
CURVA / HANDLEBAR	RUOTE / WHEELS	COPERTURE / TIRES	P/BORRACCIA / BOTTLE CAGE	
Dedaelementi Super zero	Ursus TS37 Evo Disc	Tubolari Challenge Stada	Elite	

Code
E74D-01

Campagnolo Chorus
 disc 12v



GRUPPO / GROUPSET	PEDALI / PEDALS	SELLA / SADDLE	REGGISSELLA / SEAT POST	ATTACCO / STEM
Campagnolo Chorus disc 12v	Look Keo Blade	Selle Italia SP-01 Boost	Dedaelementi Superleggero	Dedaelementi Super zero
CURVA / HANDLEBAR	RUOTE / WHEELS	COPERTURE / TIRES	P/BORRACCIA / BOTTLE CAGE	
Dedaelementi Super zero	Ursus TC37 Evo Disc	Coperture Challenge Stada	Elite	

Code
E74D-02

Shimano Dura-ace 9120 disc 11v



GRUPPO / GROUPSET	PEDALI / PEDALS	SELLA / SADDLE	REGGISSELLA / SEAT POST	ATTACCO / STEM
Shimano Dura-ace 9120 disc 11v	Look Keo Blade	Selle Italia SP-01 Boost	Dedaelementi Superleggero	Dedaelementi Super zero
CURVA / HANDLEBAR	RUOTE / WHEELS	COPERTURE / TIRES	P/BORRACCIA / BOTTLE CAGE	
Dedaelementi Super zero	Ursus Miura TS37 Evo disc	Tubolari Challenge Stada	Elite	





EUREKA AIR

Conceived for high speed sessions





EUREKA AIR

Concepita per le prestazioni ad alta velocità.

Questa meraviglia può diventare il compagno ideale per le tue sessioni ad alta velocità.

Sviluppata e testata durante i più difficili Tours Europei, Eureka Air è il nostro modo di concepire una bici aero come si deve: il telaio in monoscocca di carbonio, con passaggio cavi completamente integrato e dettagli aerodinamici, ti consegna una eccellente manovrabilità in salita come in discesa.

Conceived for high speed sessions.

This technical wonder can become the ideal companion for your high speed sessions.

Developed and tested on the best European tours, Eureka Air is our way to conceive a proper aero bike: a dedicated monocoque frame, with internal cable routing and special aerodynamic details, provides an excellent manoeuvrability on both climbs and slopes.



TELAIO MONOSCOCCA

Telaio monoscocca, realizzato in un solo pezzo in stampata unica incluse le vie interne, prodotto con la tecnologia full EPS (Expanded Polypropilene System) per un controllo della distensione dei vari strati di carbonio. Per la realizzazione di Eureka Air viene utilizzata solo fibra di alta qualità.

MONOCOQUE FRAME

Monocoque frameset made in one single piece in molded print, including internal ways, produced with full EPS (Expanded Polypropilene System) technology for a control of the relaxation of the various layers of carbon. Only high quality carbon fiber is used for Eureka Air.



DIRECT MONT BASSO

Guerciotti sposa ancora la scelta del direct mont basso perchè rappresenta ad oggi ancora la migliore soluzione a livello aerodinamico.

DIRECT MOUNT ON CHAINSTAY

Guerciotti still keeps the choice of direct mount on chainstay because nowadays it is still the best aerodynamic solution.

DESIGN POSTERIORI VERTICALI

Design dei posteriori verticali e profili delle tubazioni studiate per aumentare l'aerodinamicità, garantendo sempre alti livelli di rigidità. Reggisella aero integrato.

REAR STAYS PROFILES DESIGN

Rear stays and tubing profiles designed to increase erodynamics, always guaranteeing high stiffness. Integrated aero seatpost

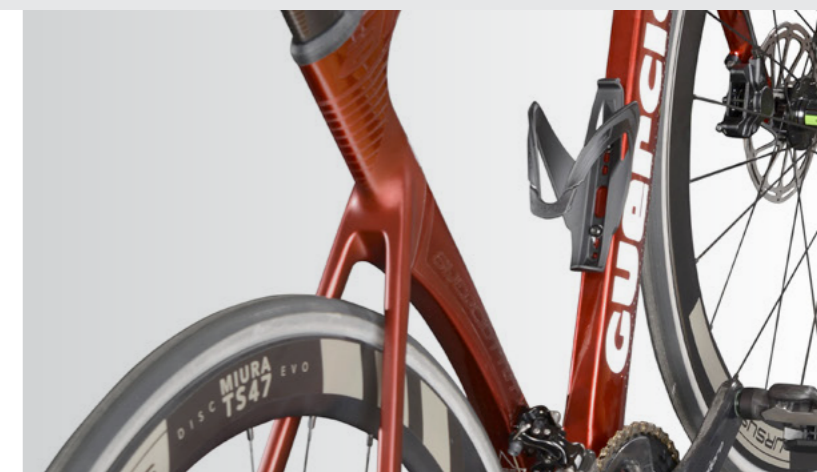

USCITA DEL CAVO DEL CAMBIO

Eureka Air prevede l'uscita del cavo del cambio dietro al forcellino, incrementando così l'aerodinamica.

OUTPUT OF REAR DERAILLEUR CABLE

Eureka Air provides the output of rear derailleur cable behind the drop out, increasing the aerodynamics.

INTEGRAL CABLE SYSTEM

Con il sistema Integral Cable i fili sono interni all'attacco e manubrio, completamente nascosti. Questo permette un aumento consistente dell'aerodinamicità, risultando un telaio magnifico dal punto di vista estetico.

INTEGRAL CABLE SYSTEM

With the integral Cable System the wires are internal at the stem and handlebar, completely hidden. This allows a substantial increase in aerodynamicity resulting a wonderful frameset from aesthetic point of view.



Code
EUREKA AIR
LIMITED EDITION
 #madeinmilano

Shimano Dura-ace 9150
 Di2 11v

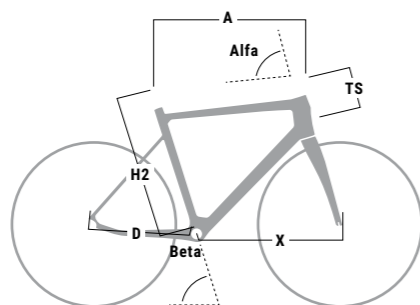

Misure	H2	A	X	D	TS	Beta	Alfa
GEOMETRIE SLOPING TELAIO EUREKA AIR							
XXS	430	505	570,4	410	95	75°	71°
XS	470	515	574	410	105	75°	72°
S	490	536	575	410	120	74°	73°
M	510	547	580	410	140	73,5°	73°
L	530	565	593	410	160	73,25°	73,5°
XL	550	582	607	410	190	73°	73,5°



- PESO TELAIO / FRAME WEIGHT :** Kg 1,090
- FORCELLA / FORK :** Monocoque
- SERIE STERZO / AHEADSET :** a spessore differenziati / oversize 1-1/8 - 1-1/2
- SCATOLA MOVIMENTO / BB SHELL :** Pressfit
- REGGISELLA / SEAT POST :** Eureka Air
- LIMITE DI PESO / WEIGHT LIMIT :** Kg 110
- PREDISPOSTO PER / PREPARED FOR :** gruppi elettronici / electronic groups
- TELAIO INCLUSO DI ATTACCO E MANUBRIO / FRAMESET INCLUDED OF STEM AND HANDLEBAR**

GRUPPO / GROUPSET	PEDALI / PEDALS	SELLA / SADDLE	REGGISELLA / SEAT POST	ATTACCO / STEM
Shimano Dura-ace 9150 Di2 11v	Look Keo Blade	Prologo Dimension	TEC for Eureka Air	TEC for Eureka Air
CURVA / HANDLEBAR	RUOTE / WHEELS	COPERTURE / TIRES	P/BORRACCIA / BOTTLE CAGE	
TEC for Eureka Air	Ursus Miura TS47 Evo	Tubolari Vittoria Corsa graphene	Elite	

Code
STARDUST
BARDIANI 2019

Campagnolo Super Record
 12v



GRUPPO / GROUPSET	PEDALI / PEDALS	SELLA / SADDLE	REGGISELLA / SEAT POST	ATTACCO / STEM
Campagnolo Super Record 12v	Look Keo Blade	Selle Italia SLR	TEC for Eureka Air	TEC for Eureka Air
CURVA / HANDLEBAR	RUOTE / WHEELS	COPERTURE / TIRES	P/BORRACCIA / BOTTLE CAGE	
TEC for Eureka Air	Ursus Miura TS47 Evo	Tubolari Vittoria Corsa graphene	Elite	



Code
AI01

Shimano Dura-ace 9100
11v



GRUPPO / GROUPSET	PEDALI / PEDALS	SELLA / SADDLE	REGGISSELLA / SEAT POST	ATTACCO / STEM
Shimano Dura-ace 9100 11v	Look Keo Blade	Prologo Dimension	TEC for Eureka Air	TEC for Eureka Air
CURVA / HANDLEBAR	RUOTE / WHEELS	COPERTURE / TIRES	P/BORRACCIA / BOTTLE CAGE	
TEC for Eureka Air	Ursus Miura TC67 evo	Coperture Vittoria Corsa Graphene	Elite	

Code
AI02

Campagnolo Chorus 12v



GRUPPO / GROUPSET	PEDALI / PEDALS	SELLA / SADDLE	REGGISSELLA / SEAT POST	ATTACCO / STEM
Campagnolo Chorus 12v	Look Keo Blade	Prologo Dimension	TEC for Eureka Air	TEC for Eureka Air
CURVA / HANDLEBAR	RUOTE / WHEELS	COPERTURE / TIRES	P/BORRACCIA / BOTTLE CAGE	
TEC for Eureka Air	Ursus Miura C50	Coperture Vittoria Corsa Graphene	Elite	

Code
AI03

Shimano Ultegra 8050 di2 11v



GRUPPO / GROUPSET	PEDALI / PEDALS	SELLA / SADDLE	REGGISSELLA / SEAT POST	ATTACCO / STEM
Shimano Ultegra 8050 di2 11v	Look Keo Blade	Prologo Dimension	TEC for Eureka Air	TEC for Eureka Air
CURVA / HANDLEBAR	RUOTE / WHEELS	COPERTURE / TIRES	P/BORRACCIA / BOTTLE CAGE	
TEC for Eureka Air	Campagnolo Bora WTO 45	Coperture Vittoria Corsa Graphene	Elite	

Code
AI04

Shimano Ultegra
8000 11v



GRUPPO / GROUPSET	PEDALI / PEDALS	SELLA / SADDLE	REGGISSELLA / SEAT POST	ATTACCO / STEM
Shimano Ultegra 8000 11v	Look Keo Blade	Prologo Dimension	TEC for Eureka Air	TEC for Eureka Air
CURVA / HANDLEBAR	RUOTE / WHEELS	COPERTURE / TIRES	P/BORRACCIA / BOTTLE CAGE	
TEC for Eureka Air	Campagnolo Bora WTO 45	Coperture Vittoria Corsa Graphene	Elite	





E740

Our superlight bike



Code
E740
LIMITED EDITION
 #madeinmilano
 Campagnolo Super Record 12V

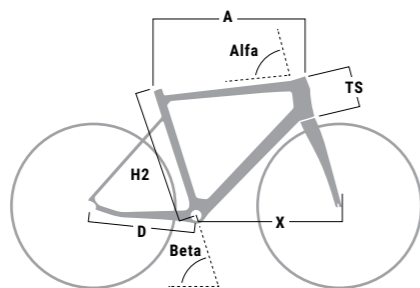

Misure	H2	A	X	D	TS	Beta	Alfa
GEOMETRIE SLOPING TELAIO E740							
XXS	450	505	571	405	105	75°	71°
XS	480	520	578	405	120	74,5°	71,5°
S	510	540	580	405	135	73,5°	72,5°
M	540	555	590	405	150	73,5°	73°
L	570	570	600	405	170	73°	73°
XL	600	590	609	405	190	72,50°	73,5°



PESO TELAIO / FRAME WEIGHT : 740 gramms
FORCELLA / FORK : Monocoque
SERIE STERZO / AHEADSET : a spessore differenziati / oversize 1-1/8 - 1-1/2
SCATOLA MOVIMENTO / BB SHELL : Pressfit
REGGISELLA / SEAT POST : 27.2
LIMITE DI PESO / WEIGHT LIMIT : 90 kg - for size XL limit weight 100 kg
PREDISPOSTO PER / PREPARED FOR : gruppi elettronici / electronic groups

GRUPPO / GROUPSET	PEDALI / PEDALS	SELLA / SADDLE	REGGISELLA / SEAT POST	ATTACCO / STEM
Campagnolo super record 12v	Look Keo blade	Selle Italia SLR	TEC	TEC
CURVA / HANDLEBAR	RUOTE / WHEELS	COPERTURE / TIRES	P/BORRACCIA / BOTTLE CAGE	
TEC	Ursus Miura TS37 evo	Tubolari Vittoria Corsa Graphene	Elite	

Code
STARDUST
BARDIANI 2019

Campagnolo Super Record 12v



GRUPPO / GROUPSET	PEDALI / PEDALS	SELLA / SADDLE	REGGISELLA / SEAT POST	ATTACCO / STEM
Campagnolo super record 12v	Look Keo blade	Selle Italia SLR	Dedalementi Superleggero	Deda Superzero
CURVA / HANDLEBAR	RUOTE / WHEELS	COPERTURE / TIRES	P/BORRACCIA / BOTTLE CAGE	
Deda Superzero	Ursus Miura TS37 evo	Tubolari Vittoria Corsa Graphene	Elite	



Code
E01

Shimano Dura-ace 9100
11v



GRUPPO / GROUPSET	PEDALI / PEDALS	SELLA / SADDLE	REGGISELLA / SEAT POST	ATTACCO / STEM
Shimano Dura-ace 9100 11v	Look Keo blade	Selle Italia SLR	TEC	TEC
CURVA / HANDLEBAR	RUOTE / WHEELS	COPERTURE / TIRES	P/BORRACCIA / BOTTLE CAGE	
TEC	Ursus Miura TS37 evo	Tubolari Vittoria Corsa Graphene	Elite	

Code
E02

Shimano Ultegra 8050 di2 11v



GRUPPO / GROUPSET	PEDALI / PEDALS	SELLA / SADDLE	REGGISELLA / SEAT POST	ATTACCO / STEM
Shimano Ultegra 8050 di2 11v	Look Keo blade	Selle Italia SLR	TEC	TEC
CURVA / HANDLEBAR	RUOTE / WHEELS	COPERTURE / TIRES	P/BORRACCIA / BOTTLE CAGE	
TEC	Ursus Miura TC37	Coperture Vittoria Corsa Graphene	Elite	



NAVIR

Stella nascente.

Navir è una nuova bicicletta da corsa con freni a disco e un sistema di rilascio meccanico semplificato dei suoi leggerissimi perni passanti.

Abbiamo realizzato questo telaio con una speciale laminazione di carbonio a spessore variabile, concepito per dotare questa bici di grande resistenza alla torsione: questo significa sicurezza in bici e alto assorbimento delle vibrazioni. Scegliendo Navir potrai avere una bicicletta da corsa leggera, sicura in frenata ed estremamente affidabile.



Rising star.

Navir is a brand new racing bicycle with disc brakes and simplified mechanic release of the ultralight thru axle.

We craft this frame with a various thickness carbon lamination, conceived to give the bike high resistance in torsion: this brings the bike safety and shock absorbing features. By choosing Navir you can have a lightweight, safe and extremely reliable bicycle.

PACCHETTO FRENI A DISCO POSTERIORE

In Navir potrai trovare tutte le più moderne soluzioni disco, come le pinze freno flat mount e le ruote con sistema perno passante. In altre parole questo significa massima precisione di frenata, controllo aerodinamico anche nel posteriore, rigidità di pedalata.

REAR DISC BRAKES

On Navir you will find all the most modern disc solutions, such as flat mount and wheels with thru axle. In other words this means maximum braking precision, aerodynamic control even in the rear part of the bike, ideal stiffness.

TELAIO OTTIMIZZATO PER FRENI A DISCO

Tutti i componenti del telaio di Navir sono realizzati in fibra di carbonio, e permettono un passaggio cavi interno mantenendo aerodinamicità e leggerezza della bici. Questo ci ha permesso di mettere le più importanti qualità di un telaio per freni a disco a disposizione di un maggior numero di ciclisti.

FRAME FOR DISC BRAKES

All the components of Navir's frame are made of carbon fiber. They allow an internal cable routing, keeping the bike aerodynamic and lightweight. This allowed us to make the most important qualities of a disc brakes frame available for a wider community of cyclists.



Code NAV01

Shimano Ultegra 8020
11v disc

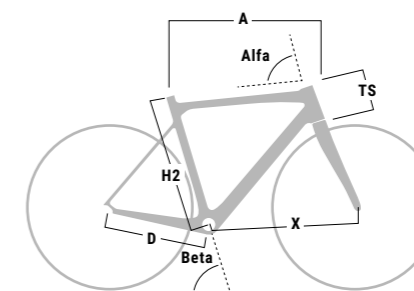

Misure	H2	A	X	D	TS	Beta	Alfa
GEOMETRIE SLOPING TELAIO NAVIR							
XXS	430	505	566,6	408	100	75.5°	72.1°
XS	470	515	578	408	110	75.5°	72°
S	500	530	579,6	408	125	74.5°	72.5°
M	530	545	584,9	408	140	73.5°	72.5°
L	560	565	609,9	408	160	73°	73°
XL	590	585	612,2	408	180	72.75°	73°



PESO TELAIO / FRAME WEIGHT : Kg 1,020

FORCELLA / FORK : Full Carbon

SERIE STERZO / AHEADSET : a spessore differenziati / oversize 1-1/8 - 1-1/2

THRU AXLE / PERNI PASSANTI

FLAT MOUNT

SCATOLA MOVIMENTO / BB SHELL : Pressfit

REGGISELLA / SEAT POST : 27.2

LIMITE DI PESO / WEIGHT LIMIT : 100 kg

PREDISPOSTO PER / PREPARED FOR : gruppi elettronici / electronic groups

GRUPPO / GROUPSET	PEDALI / PEDALS	SELLA / SADDLE	REGGISELLA / SEAT POST	ATTACCO / STEM
Shimano Ultegra 8020 disc 11v	Look Keo classic	Selle Italia XR	Dedaelementi Zero 1	Dedaelementi Zero 1
CURVA / HANDLEBAR	RUOTE / WHEELS	COPERTURE / TIRES	P/BORRACCIA / BOTTLE CAGE	
Dedaelementi Zero 1	Ursus Athon disc	Coperture Michelin pro 4	Elite	

Code
NAV02

Shimano Ultegra 8070
di2 11v disc



GRUPPO / GROUPSET	PEDALI / PEDALS	SELLA / SADDLE	REGGISELLA / SEAT POST	ATTACCO / STEM
Shimano Ultegra 8070 di2 disc 11v	Look Keo classic	Selle Italia XR	Dedaelementi Zero 1	Dedaelementi Zero 1
CURVA / HANDLEBAR	RUOTE / WHEELS	COPERTURE / TIRES	P/BORRACCIA / BOTTLE CAGE	
Dedaelementi Zero 1	TEC RSD01	Coperture Michelin pro 4	Elite	

Code
NAV03

Shimano 105 7000
11v disc



GRUPPO / GROUPSET	PEDALI / PEDALS	SELLA / SADDLE	REGGISELLA / SEAT POST	ATTACCO / STEM
Shimano 105 7000 11v disc	Look Keo classic	Selle Italia XR	Dedaelementi Zero 1	Dedaelementi Zero 1
CURVA / HANDLEBAR	RUOTE / WHEELS	COPERTURE / TIRES	P/BORRACCIA / BOTTLE CAGE	
Dedaelementi Zero 1	Mavic Aksyum Disc	Coperture Michelin pro 4	Elite	



ITALO DISC

Comfort for long-distance rides





ITALO DISC

Comfortevole per i viaggi di lunga distanza.

Italo Disc è una bici di tipo endurance, dedicata al ricordo del nostro co-fondatore Italo Guerciotti. Si tratta di un modello meno estremo di una tradizionale racing ma ugualmente performante e rigida in fase di pedalata. Oggi con freni a disco.

Le sue geometrie comode e l'elasticità del telaio sono concepite per ridurre l'affaticamento del ciclista, oltre che per assorbire maggiormente le vibrazioni. Queste caratteristiche rendono Italo scelta ideale per chi affronta percorsi ad alto chilometraggio e necessita di una posizione in sella più confortevole, mentre la possibilità di montare anche coperture da 28 mm consente di pedalare su manti stradali anche dissestati come tratti in pavé o strade bianche. Forcella e telaio rinnovati per standard disco.

Comfort for long-distance rides.

Italo Disc is an endurance bike, tribute to the memory of our co-founder Italo Guerciotti. We're talking about a less-extreme model than a racing one, but still stiff on the pedaling phase. Now with disc brakes.

Its wide geometry and its elastic frameset are conceived to reduce your weariness, rather than enhance the shock absorbing. These features make Italo an ideal choice for those who face long-distance rides and need a comfortable position on the saddle. Furthermore the possibility to equip also 28 mm tyres allow to ride also on paved roads or "strade bianche". Fork and frame design was updated in order to meet the disc brake technical requirements.

DESIGN DEL POSTERIORE VERTICALE

Il particolare design dei posteriori verticali è studiato per assorbire le vibrazioni anche su terreni accidentati, con pavé o strade bianche.

SEAT STAY DESIGN

The exclusive seat stay design is studied to absorb shocks and vibration also on paved road or "strade bianche".



FORCELLA PER FRENI A DISCO

La soluzione freno a disco permette di frenare in assoluta sicurezza. I cavi idraulici sono completamente integrati all'interno del telaio, per la massima aerodinamicità della bici. Forcella e telaio rinnovati per lo standard disco.

DISC BRAKES

The disc brakes allow a perfectly safe braking experience. The hydraulic cables are fully integrated within the frameset, this gives the bike a maximum aerodynamic performance. Fork and frame were updated to meet the standard disc requirements.

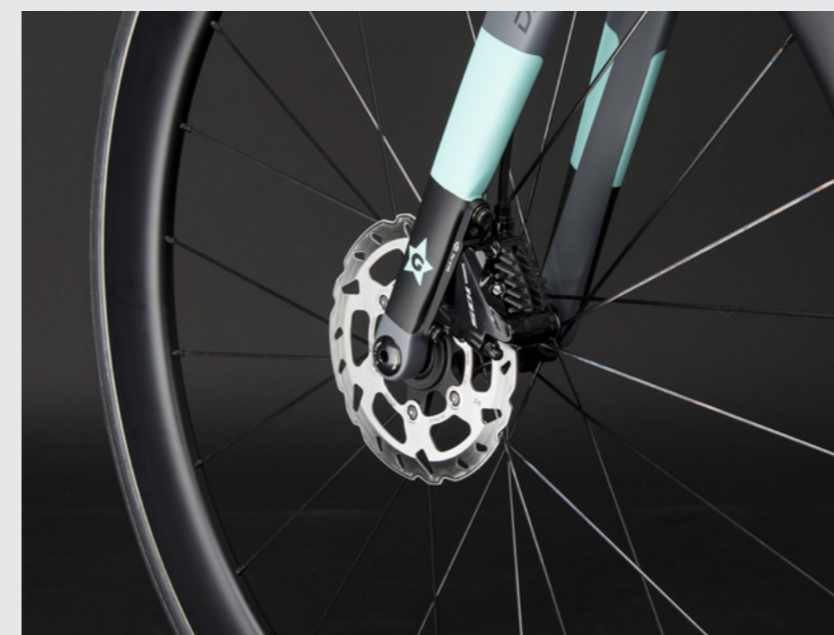

ANGOLO STERZO E GEOMETRIA

L'angolo sterzo di Italo è minore di un normale modello corsa. Questo, accompagnato alle geometrie di tubo orizzontale (più corto) e tubo sterzo (più alto), porta ad ottenere complessivamente un telaio più allungato e quindi più stabile sui fondi dissestati.

STEERING ANGLE AND GEOMETRY

Italo's steering angle is narrower than a normal racing model. This, together with the geometry of the top tube (shorter) and the head tube (higher), leads to a more elongated frame and therefore more stable on the uneven surfaces.



Code
ITAD01

Shimano Ultegra 8020
11v disc

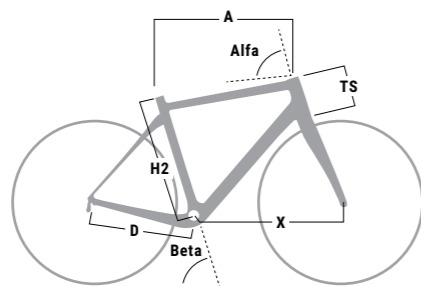

Misure	H2	A	X	D	TS	Beta	Alfa
GEOMETRIE TELAIO ITALO DISC							
XXS	450	513,2	579,5	406	114,6	75°	71°
XS	480	526,9	585,6	406	130,7	74,5°	71,5°
S	500	540,4	591,9	408	147,8	74°	72°
M	520	556,7	598,3	408	165,9	73,5°	72,5°
L	550	572	608,8	411	183,7	73°	72,5°
XL	580	588,7	619,8	411	203,1	72,5°	72,5°



PESO TELAIO / FRAME WEIGHT : Kg 1,130

FORCELLA / FORK : Full Carbon

SERIE STERZO / AHEADSET : a spessore differenziati / oversize 1-1/8 - 1-1/2

THRU AXLE / PERNI PASSANTI

FLAT MOUNT

SCATOLA MOVIMENTO / BB SHELL : Pressfit

REGGISELLA / SEAT POST : 31.6

LIMITE DI PESO / WEIGHT LIMIT : 110 kg

PREDISPOSTO PER / PREPARED FOR : gruppi elettronici / electronic groups

GRUPPO / GROUPSET	PEDALI / PEDALS	SELLA / SADDLE	REGGISELLA / SEAT POST	ATTACCO / STEM
Shimano Ultegra 8020 disc 11v	Look Keo classic	Prologo Nago	Dedaelementi Zero 1	Dedaelementi Zero 1
CURVA / HANDLEBAR	RUOTE / WHEELS	COPERTURE / TIRES	P/BORRACCIA / BOTTLE CAGE	
Dedaelementi Zero 1	Vision Team 30 COMP disc	Copertura Vittoria Zaffiro pro	Elite	

Code
ITAD02

Shimano 105 7000
11v disc



GRUPPO / GROUPSET	PEDALI / PEDALS	SELLA / SADDLE	REGGISELLA / SEAT POST	ATTACCO / STEM
Shimano 105 7000 disc 11v	Look Keo classic	Prologo Nago	Dedaelementi Zero 1	Dedaelementi Zero 1
CURVA / HANDLEBAR	RUOTE / WHEELS	COPERTURE / TIRES	P/BORRACCIA / BOTTLE CAGE	
Dedaelementi Zero 1	Vision Team 30 COMP disc	Copertura Vittoria Zaffiro pro	Elite	

Code
ITAD03

Shimano 105 7000
11v disc



GRUPPO / GROUPSET	PEDALI / PEDALS	SELLA / SADDLE	REGGISELLA / SEAT POST	ATTACCO / STEM
Shimano 105 7000 11v disc	Look Keo classic	Prologo Nago	Dedaelementi Zero 1	Dedaelementi Zero 1
CURVA / HANDLEBAR	RUOTE / WHEELS	COPERTURE / TIRES	P/BORRACCIA / BOTTLE CAGE	
Dedaelementi Zero 1	Vision Team 30 COMP disc	Copertura Vittoria Zaffiro pro	Elite	



ITALO

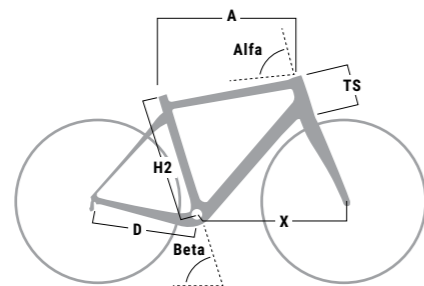

Misure	H2	A	X	D	TS	Beta	Alfa
GEOMETRIE TELAIO ITALO							
XXS	450	513,2	579,5	406	114,6	75°	71°
XS	480	526,9	585,6	406	130,7	74,5°	71,5°
S	500	540,4	591,9	408	147,8	74°	72°
M	520	556,7	598,3	408	165,9	73,5°	72,5°
L	550	572	608,8	411	183,7	73°	72,5°
XL	580	588,7	619,8	411	203,1	72,5°	72,5°

Code
ITA01

Shimano Ultegra
8000 11v



PESO TELAIO / FRAME WEIGHT : Kg 1,085

FORCELLA / FORK : Full Carbon

SERIE STERZO / AHEADSET : a spessore differenziati / oversize 1-1/8 - 1-1/2

SCATOLA MOVIMENTO / BB SHELL : Pressfit

REGGISSELLA / SEAT POST : 31.6

LIMITE DI PESO / WEIGHT LIMIT : 110 kg

PREDISPOSTO PER / PREPARED FOR : gruppi elettronici / electronic groups

GRUPPO / GROUPSET	PEDALI / PEDALS	SELLA / SADDLE	REGGISSELLA / SEAT POST	ATTACCO / STEM
Shimano Ultegra 8000 11v	Look Keo classic	Prologo Nago	Dedaelementi Zero 1	Dedaelementi Zero 1
CURVA / HANDLEBAR	RUOTE / WHEELS	COPERTURE / TIRES	P/BORRACCIA / BOTTLE CAGE	
Dedaelementi Zero 1	Ursus Izar	Coperture Vittoria Zaffiro Pro	Elite	

Code
ITA02

Shimano 105 7000 11v



GRUPPO / GROUPSET	PEDALI / PEDALS	SELLA / SADDLE	REGGISSELLA / SEAT POST	ATTACCO / STEM
Shimano 105 7000 11v	Look Keo classic	Prologo Nago	Dedaelementi Zero 1	Dedaelementi Zero 1
CURVA / HANDLEBAR	RUOTE / WHEELS	COPERTURE / TIRES	P/BORRACCIA / BOTTLE CAGE	
Dedaelementi Zero 1	Vision Team 35 COMP	Coperture Vittoria Zaffiro pro	Elite	

Code
ITA03

Shimano 105 7000 11v



GRUPPO / GROUPSET	PEDALI / PEDALS	SELLA / SADDLE	REGGISSELLA / SEAT POST	ATTACCO / STEM
Shimano 105 7000 11v	Look Keo classic	Prologo Nago	Dedaelementi Zero 1	Dedaelementi Zero 1
CURVA / HANDLEBAR	RUOTE / WHEELS	COPERTURE / TIRES	P/BORRACCIA / BOTTLE CAGE	
Dedaelementi Zero 1	Vision Team 35 COMP	Coperture Vittoria Zaffiro pro	Elite	





CARTESIO DISC

A versatile cycling companion



CARTESIO DISC



Una versatile compagna.

Cartesio Disc è il nostro prodotto corsa entry-level in carbonio con freni a disco, ma è molto più che una bici entry level.

Il telaio è pensato per essere estremamente rigido ma allo stesso tempo leggero. Per questo abbiamo scelto fibre di carbonio di alta qualità per produrre sia il triangolo in monoscocca che il carro posteriore, che sono incollati insieme alla perfezione. Inoltre il passaggio cavi è interno, mentre design e geometrie sono sviluppate per consegnarti un profilo altamente racing. Forcella e telaio rinnovati per lo standard disco. Disponibile per gruppi meccanici ed elettronici, Cartesio è un versatile compagno in ogni condizione.

A versatile cycling companion.

Cartesio Disc is our entry-level road racing carbon product with disc brakes, but it's more than a normal entry-level bike.

The frame is designed to be extremely stiff but also very lightweight, that's why we have chosen high quality carbon fiber to produce both the monocoque triangle and the rear stays, which are perfectly glued together. Furthermore the cable routing is internal, while design and geometries were developed to provide an incredibly racing profile. Fork and frame were updated to meet the standard disc requirements. Available for mechanic and electronic groupsets, Cartesio is a versatile companion for every condition.

UN TELAIO SPETTACOLARE

Per Cartesio abbiamo adottato un sistema di passaggio cavi interno: questo rende la bici bella come un'ammiraglia. La novità della nuova stagione è in ogni caso la predisposizione del telaio per gruppi elettronici, che posiziona Cartesio un gradino più in alto rispetto ai normali modelli entry level.

A SPECTACULAR FRAME

Cartesio comes with an integrated cable routing system: this make the bike beautiful like a top-class model. The big novelty is indeed the predisposition of the frame for electronic groups, which places Cartesio a step ahead the common entry level models.



FORCELLA PER FRENI A DISCO

La soluzione freno a disco permette di frenare in assoluta sicurezza. I cavi idraulici sono completamente integrati all'interno del telaio, per la massima aerodinamicità della bici. Forcella e telaio rinnovati per lo standard disco.

DISC BRAKES

The disc brakes allow a perfectly safe braking experience. The hydraulic cables are fully integrated within the frameset, this gives the bike a maximum aerodynamic performance. Fork and frame were updated to meet the standard disc requirements.



IDEALE PER I GIOVANI

Il design dei posteriori è studiato per garantire una maggiore rigidità. Guerciotti è inoltre riuscito a studiare una soluzione che permette di montare anche pacchi pignoni larghi. Un upgrade importante specialmente per i giovani ciclisti, che spesso necessitano di usare in partenza un rapporto 18.

GOOD FOR YOUNGSTERS

The design of the rear tubes ensures a great stiffness. Guerciotti has also managed to design a solution that allows larger cassettes to be mounted. This is an important upgrade especially for young cyclists, who often need to use a starting 18 gear.



Code
CAD01

Shimano 105 7000 disc
11v

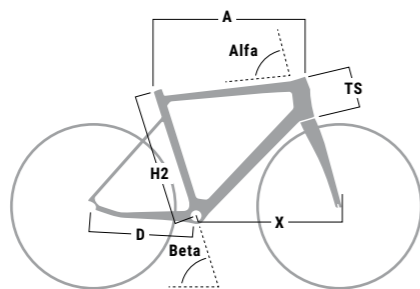

Misure	H2	A	D	TS	Beta	Alfa
GEOMETRIE SLOPING TELAIO CARTESIO DISC						
XS	430	495	410	105	75°	71°
S	475	515	410	120	74,5°	72°
M	530	545	410	151	73,5°	73°
L	550	565	410	170	73,5°	73°
XL	580	585	410	200	73,5°	73°



PESO TELAIO / FRAME WEIGHT : Kg 1,100

FORCELLA / FORK : Full Carbon

SERIE STERZO / AHEADSET : a spessore differenziati / oversize 1-1/8 - 1-1/2

THRU AXLE / PERNI PASSANTI

FLAT MOUNT

SCATOLA MOVIMENTO / BB SHELL : Pressfit

REGGISELLA / SEAT POST : 27.2

LIMITE DI PESO / WEIGHT LIMIT : 120 kg

PREDISPOSTO PER / PREPARED FOR : gruppi elettronici / electronic groups

GRUPPO / GROUPSET	PEDALI / PEDALS	SELLA / SADDLE	REGGISELLA / SEAT POST	ATTACCO / STEM
Shimano 105 7000 disc 11v	Look Keo classic	Selle Italia X3 Boost	Dedaelementi Zero	Dedaelementi Zero
CURVA / HANDLEBAR	RUOTE / WHEELS	COPERTURE / TIRES	P/BORRACCIA / BOTTLE CAGE	
Dedaelementi Zero	Tec Racing Disc	Coperture Vittoria Zafiro pro	Elite	

Code
CAD02

Shimano 105 7000 disc
11v



GRUPPO / GROUPSET	PEDALI / PEDALS	SELLA / SADDLE	REGGISELLA / SEAT POST	ATTACCO / STEM
Shimano 105 7000 disc 11v	Look Keo classic	Selle Italia X3 Boost	Dedaelementi Zero	Dedaelementi Zero
CURVA / HANDLEBAR	RUOTE / WHEELS	COPERTURE / TIRES	P/BORRACCIA / BOTTLE CAGE	
Dedaelementi Zero	Tec Racing Disc	Coperture Vittoria Zafiro pro	Elite	

Code
CAD03

Shimano Ultegra 8020 11v



GRUPPO / GROUPSET	PEDALI / PEDALS	SELLA / SADDLE	REGGISELLA / SEAT POST	ATTACCO / STEM
Shimano Ultegra 8020 11v	Look Keo classic	Selle Italia X3 Boost	Dedaelementi Zero	Dedaelementi Zero
CURVA / HANDLEBAR	RUOTE / WHEELS	COPERTURE / TIRES	P/BORRACCIA / BOTTLE CAGE	
Dedaelementi Zero	Mavic Aksyum disc	Coperture Vittoria Zafiro pro	Elite	



CARTESIO

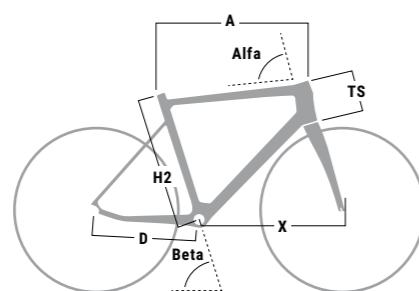

Misure	H2	A	D	TS	Beta	Alfa
GEOMETRIE SLOPING TELAIO CARTESIO						
XS	430	495	410	105	75°	71°
S	475	515	410	120	74,5°	72°
M	530	545	410	151	73,5°	73°
L	550	565	410	170	73,5°	73°
XL	580	585	410	200	73,5°	73°

Code
CA01

Shimano Ultegra
8000 11v



PESO TELAIO / FRAME WEIGHT : Kg 1,050

FORCELLA / FORK : Carbon

SERIE STERZO / AHEADSET : a spessore differenziati / oversize 1-1/8 - 1-1/2

SCATOLA MOVIMENTO / BB SHELL : Pressfit

REGGISSELLA / SEAT POST : 27.2

LIMITE DI PESO / WEIGHT LIMIT : 120 kg

PREDISPOSTO PER / PREPARED FOR : gruppi elettronici / electronic groups

GRUPPO / GROUPSET	PEDALI / PEDALS	SELLA / SADDLE	REGGISSELLA / SEAT POST	ATTACCO / STEM
Shimano Ultegra 8000 11v	Look Keo classic	Selle Italia X1	Dedaelementi Zero	Dedaelementi Zero
CURVA / HANDLEBAR	RUOTE / WHEELS	COPERTURE / TIRES	P/BORRACCIA / BOTTLE CAGE	
Dedaelementi Zero	Mavic Aksyum	Coperture Vittoria Zafiro pro	Elite	

Code
CA02

Shimano 105 7000 11v



GRUPPO / GROUPSET	PEDALI / PEDALS	SELLA / SADDLE	REGGISSELLA / SEAT POST	ATTACCO / STEM
Shimano 105 7000 11v	Look keo classic	Selle Italia X1	Dedaelementi Zero	Dedaelementi Zero
CURVA / HANDLEBAR	RUOTE / WHEELS	COPERTURE / TIRES	P/BORRACCIA / BOTTLE CAGE	
Dedaelementi Zero	Vision Team 30 COMP	Coperture Vittoria Zaffiro Pro	Elite	

Code
CA03

Shimano Tiagra 4700 10v



GRUPPO / GROUPSET	PEDALI / PEDALS	SELLA / SADDLE	REGGISSELLA / SEAT POST	ATTACCO / STEM
Shimano Tiagra 4700 10v	Look keo classic	Selle Italia X1	Dedaelementi Zero	Dedaelementi Zero
CRANKSET / GUARNITURA	RUOTE / WHEELS	COPERTURE / TIRES	P/BORRACCIA / BOTTLE CAGE	
FSA Omega CT	Gipiemme Techno 324	Vittoria Zaffiro Pro	Elite	
FRENI / BRAKES		CURVA / HANDLEBAR		
Tektro		Dedaelementi Zero		



SAN SIRO

Code
SA01

Shimano Sora 9s

SAN SIRO.

San Siro il nostro prodotto entry level in alluminio, ma presenta soluzioni tecniche studiate per rendere questa bici appetibile da un pubblico esigente. Il design del telaio è di alto livello e permette infatti un passaggio cavi interno, mentre la nuova veste grafica la rende ancora più attraente. San Siro, la bicicletta ideale per iniziare a pedalare con stile.

SAN SIRO.

San Siro our entry level alloy product, but it offers technical solutions designed to make this bike attractive for demanding riders. The high level frame design allow for example the internal cable routing, while the new livery makes it even more attractive than the previous model. San Siro, the right bicycle to start riding in style.



PESO TELAIO / FRAME WEIGHT : Kg 1,600

FORCELLA / FORK : Carbon

SERIE STERZO / AHEADSET : a spessore differenziati / oversize 1-1/8 - 1-1/2

SCATOLA MOVIMENTO / BB SHELL : BSA

REGGISELLA / SEAT POST : 31.6

LIMITE DI PESO / WEIGHT LIMIT : 120 kg

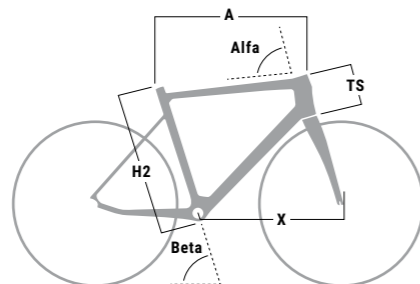

Misure	H2	A	X	TS	Beta	Alfa
GEOMETRIE SLOPING TELAIO SAN SIRO						
XXS	460	490	545,4	100	74°	71°
XS	490	515	570,8	110	74°	71°
S	510	525	578	120	74°	71°
M	530	550	607,7	150	73,5°	71°
L	550	570	618,4	175	73,5°	71°
XL	580	580	628,6	195	73°	71°

GRUPPO / GROUPSET	PEDALI / PEDALS	SELLA / SADDLE	REGGISELLA / SEAT POST	ATTACCO / STEM
Shimano Sora 9s	Look keo classic	Selle Italia X1	Dedaelementi Zero	Dedaelementi Zero
CRANKSET / GUARNITURA	RUOTE / WHEELS	COPERTURE / TIRES	P/BORRACCIA / BOTTLE CAGE	
FSA Vero	Tec Racing	Vittoria Zaffiro Pro	Elite	
FRENI / BRAKES		CURVA / HANDLEBAR		
Tektro		Dedaelementi Zero		

Code
SA03

Shimano Sora 9s



GRUPPO / GROUPSET	PEDALI / PEDALS	SELLA / SADDLE	REGGISELLA / SEAT POST	ATTACCO / STEM
Shimano Sora 9s	Look keo classic	Selle Italia X1	Dedaelementi Zero	Dedaelementi Zero
CRANKSET / GUARNITURA	RUOTE / WHEELS	COPERTURE / TIRES	P/BORRACCIA / BOTTLE CAGE	
FSA Vero	Tec Racing	Vittoria Zaffiro Pro	Elite	
FRENI / BRAKES		CURVA / HANDLEBAR		
Tektro		Dedaelementi Zero		



RECORD

Code

RECORD

Campagnolo Potenza 11v

UN EROE VINTAGE.

Record ci porta indietro ai giorni d'oro del ciclismo: un buon tributo per la storia del nostro iconico brand e per i grandi campioni che hanno pedalato con la "Stella più luminosa di Milano" tra gli anni settanta e gli anni novanta. Record è inoltre altamente personalizzabile nei colori.

A VINTAGE HERO.

Record takes us back in the days of classic cycling: a good tribute for our iconic brand's history and for the great champions which rode the "Brightest Star in Milan" between the seventies and the eighties. Record is also highly customisable in colors to match every taste.

Metallic Pink RE01	Pink RE06
Silver RE02	Red RE07
Orange RE03	Green RE08
White RE04	Black RE09
Blue RE05	Mustard RE10



PESO TELAIO / FRAME WEIGHT : Kg 1,680

FORCELLA / FORK : Acciaio / Steel

SERIE STERZO / AHEADSET : 1" Threaded

SCATOLA MOVIMENTO / BB SHELL : BSA

REGGISSELLA / SEAT POST : 27.2

LIMITE DI PESO / WEIGHT LIMIT : 130 kg

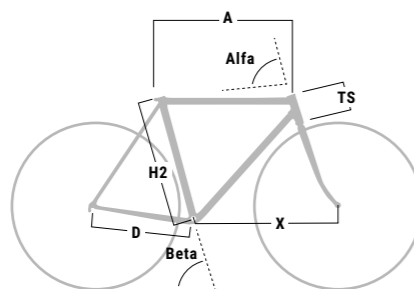

H2	H	TS	Alfa	Beta	X	D	P
GEOMETRIE TELAIO RECORD							
500	515	82	71,5°	75°	573	406	27
520	525	95	72°	74,5°	574	406	26,5
530	535	105	72,5°	73,5°	570	410	26,5
540	540	115	72,5°	73,5°	575	410	26,5
550	545	124	73°	73,5°	576	410	26,5
560	555	132	73°	73°	581	410	26,5
570	565	141	73°	73°	591	410	26,5
580	575	150	73°	73°	600	410	26,5
600	585	165	73,5°	73°	605	410	26,5

GRUPPO / GROUPSET	PEDALI / PEDALS	SELLA / SADDLE	REGGISSELLA / SEAT POST	ATTACCO / STEM
Campagnolo Potenza 11v	Keo classic	Selle Italia SL	Dedaelementi Zero 1	Dedaelementi Zero 1
CURVA / HANDLEBAR	RUOTE / WHEELS	COPERTURE / TIRES	P/BORRACCIA / BOTTLE CAGE	
Miche Supertype	Campagnolo Kamsin	Vittoria Zaffiro pro	Elite	

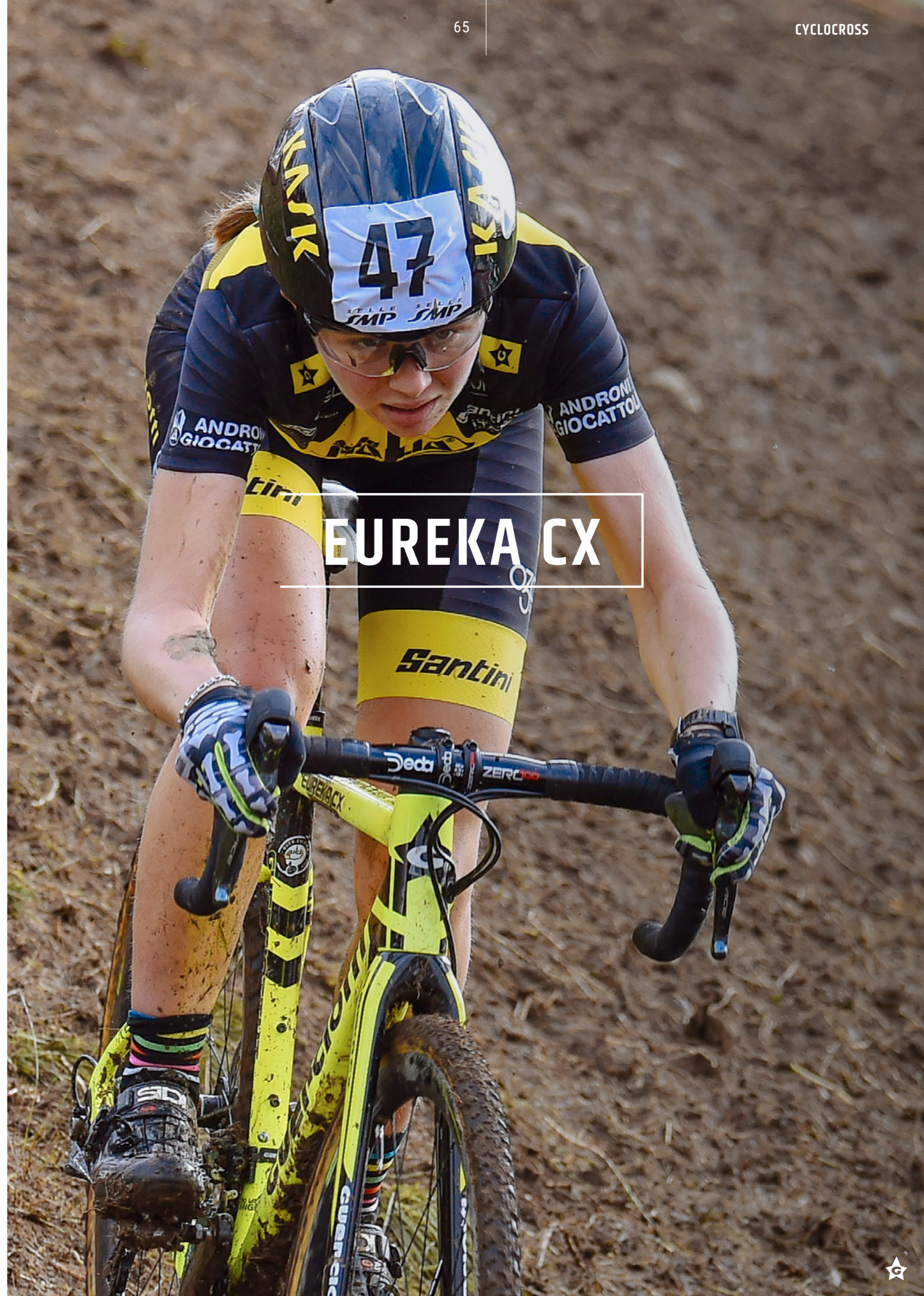

EUREKA CX



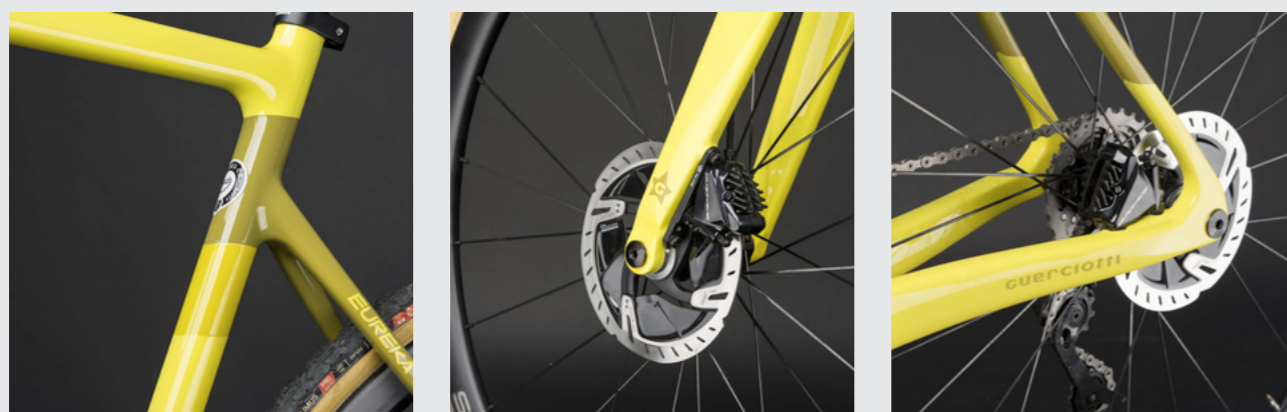

Specialità della casa.

Il ciclocross è nel nostro sangue: dopo anni di successi ottenuti sui tracciati più infangati d'Europa, abbiamo sentito la necessità di realizzare una bici esclusivamente pensata per il ciclocross.

Il suo telaio in carbonio, strategicamente rinforzato nei punti di maggior torsione, può trasportare carichi superiori del 30% a quelli previsti dalla normativa vigente. Questa bici è resistente ma elastica per aiutarti nelle azioni di rilancio, mentre i freni a disco permettono una frenata precisa e istantanea anche in condizioni di percorsi estremamente fangosi. Sviluppata in sinergia con Gioele Bertolini e Jakob Dorigoni, alfieri del ciclocross italiano, Eureka CX è oggi una delle bici da ciclocross più vincenti.

Specialty of the house.

Cyclocross is in our blood: after successful decades spent on the European most difficult muddy paths, we've felt it was time for Guerciotti to have our own cyclocross machine.

Eureka CX is that machine. Its monocoque frame, strategically reinforced on special torsion points, can carry heavy loads. This bike is resistant but elastic, in order to help the rider in reboot actions, while the disc brakes allow an instant and precise braking even on dirt conditions. Developed with Gioele Bertolini and Jakob Dorigoni, Italian cyclocross heroes, Eureka CX is today one of the most winning cyclocross bikes.

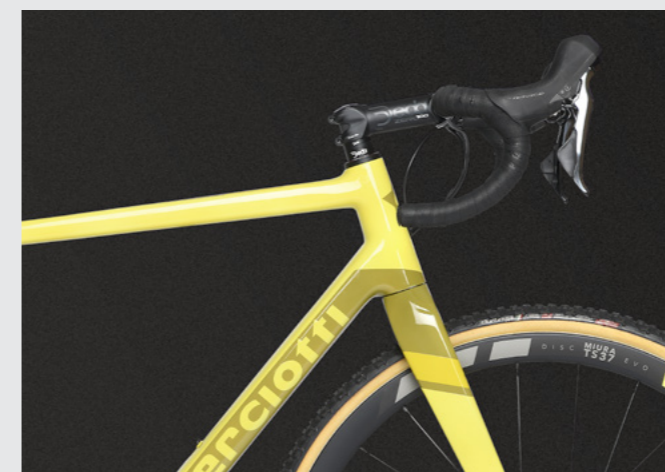

TELAIO

Evoluzione del modello Lembeek disc, da cui recupera le caratteristiche distintive, Eureka CX si distingue per il peso ridotto. Telaio estremamente leggero ed elastico: per produrlo viene utilizzata solo fibra di altissima qualità. Il carbonio altissimo modulo è usato per rinforzare i punti di torsione massima, la zona freno a disco del carro posteriore e la scatola movimento.

FRAME

Evolution of the Lembeek disc model, Eureka CX stands out for its reduced weight. Extremely light and elastic frame: only quality fiber was used to produce it: The high carbon module is used to reinforce the maximum torsion points, the disc brake zone, the chainstay and the BB shell area.

Code
CX01

Shimano Dura-ace 9120 disc 11v

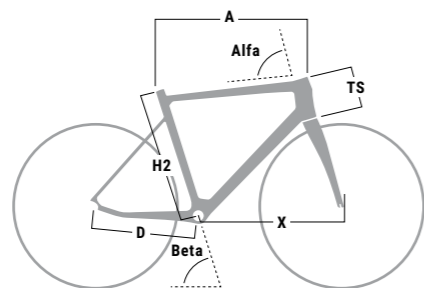

Misure	H2	A	X	D	TS	Beta	Alfa
GEOMETRIE SLOPING TELAIO EUREKA CX							
XS	490	510	590	425	110	75°	71°
S	520	535	590	425	130	74°	71,5°
M	540	545	591	425	140	73,5°	72°
L	560	560	601	425	160	73°	72°
XL	580	575	616	425	180	73°	72°



PESO TELAIO / FRAME WEIGHT : Kg 1,050
FORCELLA / FORK : Monocoque
SERIE STERZO / AHEADSET : a spessore differenziati / oversize 1-1/8 - 1-1/2
THRU AXLE / PERNI PASSANTI
FLAT MOUNT
SCATOLA MOVIMENTO / BB SHELL : Pressfit
LIMITE DI PESO / WEIGHT LIMIT : 100 kg
PREDISPOSTO PER / PREPARED FOR : gruppi elettronici / electronic groups

GRUPPO / GROUPSET	PEDALI / PEDALS	SELLA / SADDLE	REGGISELLA / SEAT POST
Shimano Dura-ace 9120 disc 11v	shimano XTR	Selle Italia SLR	Dedaelementi Zero 100
CURVA / HANDLEBAR	RUOTE / WHEELS	COPERTURE / TIRES	ATTACCO / STEM
Dedaelementi Zero 100	Ursus Miura TS37 EVO disc	Tubolari Challenge Grifo	Dedaelementi Zero 100

Code
CX02

Shimano Ultegra 8020 disc 11v



GRUPPO / GROUPSET	PEDALI / PEDALS	SELLA / SADDLE	REGGISELLA / SEAT POST
Shimano Ultegra 8020 disc 11v	shimano XTR	Selle Italia SLR	Dedaelementi Zero 100
CURVA / HANDLEBAR	RUOTE / WHEELS	COPERTURE / TIRES	ATTACCO / STEM
Dedaelementi Zero 100	Ursus Miura TS37 EVO disc	Tubolari Challenge Grifo	Dedaelementi Zero 100

Code
CX03

Sram Force 1



GRUPPO / GROUPSET	PEDALI / PEDALS	SELLA / SADDLE	REGGISELLA / SEAT POST
Sram Force 1	shimano XTR	Selle Italia SLR	Dedaelementi Zero 100
CURVA / HANDLEBAR	RUOTE / WHEELS	COPERTURE / TIRES	ATTACCO / STEM
Dedaelementi Zero 100	Ursus Miura TS37 EVO disc	Tubolari Challenge Grifo	Dedaelementi Zero 100



LEMBEEK DISC

Code

LED01

Shimano Ultegra 8020 disc 11v



PESO TELAIO / FRAME WEIGHT : Kg 1,130

FORCELLA / FORK : Full Carbon

SERIE STERZO / AHEADSET : a spessore differenziati / oversize 1-1/8 - 1-1/2

THRU AXLE / PERNI PASSANTI

FLAT MOUNT

SCATOLA MOVIMENTO / BB SHELL : Pressfit

REGGISELLA / SEAT POST : 27.2

LIMITE DI PESO / WEIGHT LIMIT : 100 kg

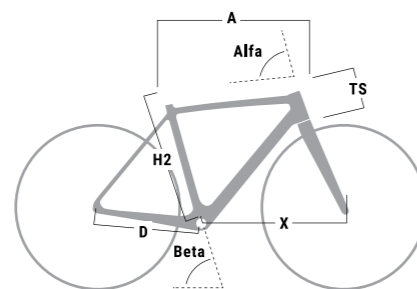

Misure	H2	A	X	D	TS	Beta
GEOMETRIE SLOPING TELAIO LEMBEEK DISC						
XS	510	505	575	425	115	74,5°
S	530	520	578	425	135	74°
M	550	523	592	425	145	74°
L	570	545	603	425	155	73,8°
XL	590	565	603	425	175	73°

LEMBEEK DISC.

Lembeek disc rappresenta il nuovo entrata gamma in carbonio per ciclocross. Nuova versione del modello che ha regalato tanti successi al Selle Italia Guerciotti Elite team. Freni a disco flat mount e perni passanti. Come tutti i top di gamma del catalogo Guerciotti, Lembeek disc è predisposto anche per gruppi elettronici.

LEMBEEK DISC.

Lembeek disc is the new entry carbon product for cyclocross. New version of the model that has given so many victories to the Selle Italia Guerciotti Elite team. Flat mount disc brakes and thru axle. Like the other the top products in the Guerciotti catalog, Lembeek disc is also designed for electronic groups.

Code

LED02

Force Rival 1



GRUPPO / GROUPSET	PEDALI / PEDALS	SELLA / SADDLE	REGGISELLA / SEAT POST
Force Rival 1	PDM540	Selle Italia XLR	Dedaelementi Zero 1
CURVA / HANDLEBAR	RUOTE / WHEELS	COPERTURE / TIRES	ATTACCO / STEM
Dedaelementi Zero 1	TEC Syntax	Coperture Challenge Grifo	Dedaelementi Zero 1

Code

LED03

Shimano 105 7000 disc 11v



GRUPPO / GROUPSET	PEDALI / PEDALS	SELLA / SADDLE	REGGISELLA / SEAT POST
Shimano 105 7000 disc 11v	PDM520	Selle Italia XLR	Dedaelementi Zero 1
CURVA / HANDLEBAR	RUOTE / WHEELS	COPERTURE / TIRES	ATTACCO / STEM
Dedaelementi Zero 1	Vision Team 30 COMP disc	Coperture Challenge Grifo	Dedaelementi Zero 1

GIETEN

Code
GIE01

Shimano 105 7000 disc 11v

GIETEN.

Gieten è il modello entrata di gamma in alluminio dedicato al ciclocross. Rinnovata nella livrea, è una bici unica per via dell'utilizzo di soluzioni disco di alto profilo come freno passante e pinze freno flat mount, ma anche per il passaggio cavi interni, particolare fondamentale nel cross. Gieten è molto più di un prodotto economico: l'ampia scelta di misure telaio anche molto piccole la rende ideale per addestrare le nuove leve di giovani ciclocrossisti.

GIETEN.

Gieten is the entry-level alloy model conceived for cyclocross. With a new livery design, it is an unique bike: we selected high-profile disc solutions such as thru axle and flat-mount, rather than the internal cable routing, a fundamental detail on cross races. Gieten is much more than an economic product: the wide choice of frame sizes (even very small sizes) makes it suitable for the training sessions of young cyclocross riders.



PESO TELAIO / FRAME WEIGHT : Kg 1,700

FORCELLA / FORK : Carbon

SERIE STERZO / AHEADSET : a spessore differenziati / oversize 1-1/8 - 1-1/2

THRU AXLE / PERNI PASSANTI

FLAT MOUNT

SCATOLA MOVIMENTO / BB SHELL : BSA

REGGISELLA / SEAT POST : 27.2

LIMITE DI PESO / WEIGHT LIMIT : 120 kg

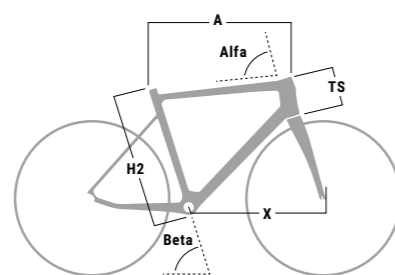

Misure	H2	A	X	TS	Beta	Alfa
GEOMETRIE SLOPING TELAIO GIETEN						
XXS	460	495	575,1	100	75,5°	70,5°
XS	480	510	590	100	75,5°	70,5°
S	500	525	601,4	115	75°	70,5°
M	520	535	602,2	125	74,5°	71°
L	540	545	602,8	135	74°	71,5°
XL	560	560	607,6	145	73,5°	72°

GRUPPO / GROUPSET	PEDALI / PEDALS	SELLA / SADDLE	REGGISELLA / SEAT POST
Shimano 105 7000 disc 11v	Shimano PDM 520	Selle Italia X1	Dedalementi Zero
CURVA / HANDLEBAR	RUOTE / WHEELS	COPERTURE / TIRES	ATTACCO / STEM
Dedalementi Zero	Tec Racing disc	Coperture challenge grifo	Dedalementi Zero

Code
GIE02

Apex 1



GRUPPO / GROUPSET	PEDALI / PEDALS	SELLA / SADDLE	REGGISELLA / SEAT POST
Apex 1	Shimano PDM 520	Selle Italia X1	Dedalementi Zero
CURVA / HANDLEBAR	RUOTE / WHEELS	COPERTURE / TIRES	ATTACCO / STEM
Dedalementi Zero	Tec Racing disc	Coperture challenge grifo	Dedalementi Zero

Code
GIE03

Shimano 105 7000 disc 11v



GRUPPO / GROUPSET	PEDALI / PEDALS	SELLA / SADDLE	REGGISELLA / SEAT POST
Shimano 105 7000 disc 11v	Shimano PDM 520	Selle Italia X1	Dedalementi Zero
CURVA / HANDLEBAR	RUOTE / WHEELS	COPERTURE / TIRES	ATTACCO / STEM
Dedalementi Zero	Tec Syntax	Coperture challenge grifo	Dedalementi Zero



BRERA

Ride on any trail, in any season.



BRERA

Pedala in ogni terreno,
in ogni stagione.

Se il gravel per molti rappresenta una novità, per Guerciotti è la naturale evoluzione di un'anima cross.

Rispetto alle bici che riscuotono successi negli sterrati di tutta Europa questi prodotti si caratterizzano per una posizione di guida più confortevole, ma conservano tuttavia caratteristiche tecniche di alto livello come i freni a disco, la leggerezza del telaio e lo spazio aggiuntivo per il passaggio di pneumatici più larghi. Chiude il cerchio la nuova veste grafica da urlo, che rende questa bici un vero must per gli appassionati. Pedala in qualsiasi terreno e in qualsiasi stagione, scegli le gravel bike Guerciotti!

Ride on any trail,
in any season.

If gravel is a novelty for many, for Guerciotti it is the natural evolution of a cross-oriented soul.

Compared to the bikes that collect hits in dirt roads across Europe, these products are characterized by a more comfortable driving position, but still retain high-level technical features such as disc brakes, the lightness of the frame and the additional space for the passage of wider tires. Last but not least Brera has a new graphic design that makes this bike a real must have for the gravel enthusiasts. Ride on any trail, in any season. Choose the Guerciotti gravel bike!



BRERA: L'ANIMA DI MILANO

Brera è la nostra top di gamma per il gravel. Telaio in fibra di carbonio con rinforzo nelle zone di massima torsione: questa lavorazione consente di ottenere una bici elastica ma al tempo stessa rigida in fase di rilancio della pedalata. Estremamente confortevole, Brera è anche esteticamente fatta per stupire.

BRERA: THE MILANESE SOUL

Brera is our high-end model for gravel. Carbon fiber frame, reinforced on the critic torsion areas: this allow to obtain an elastic bike, but also rigid while riding. Extremely comfortable, Brera is therefore aesthetically beautiful.

Code
BR01

Shimano Ultegra 8020
disc 11v

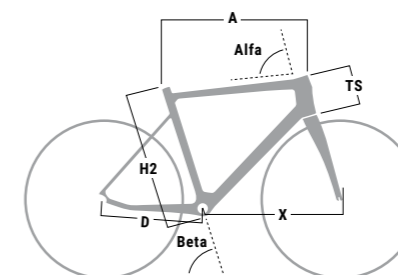

Misure	H2	A	X	D	TS	Beta	Alfa
GEOMETRIE SLOPING TELAIO BRERA							
XS	490	525	598	435	120	74,5°	70,5°
S	520	535	601	435	140	74°	71°
M	540	545	601	435	150	73,5°	71,5°
L	560	560	606	435	170	73°	72°
XL	580	575	616	435	190	72,5°	72°



PESO TELAIO / FRAME WEIGHT : Kg 1,270

FORCELLA / FORK : Full Carbon

REGGISELLA / SEAT POST : 27.2

SERIE STERZO / AHEADSET : a spessore differenziati / oversize 1-1/8 - 1-1/2

SCATOLA MOVIMENTO / BB SHELL : Pressfit

THRU AXLE / PERNI PASSANTI

FLAT MOUNT

LIMITE DI PESO / WEIGHT LIMIT : 120 kg

PREDISPOSTO PER / PREPARED FOR : gruppi elettronici / electronic groups

GRUPPO / GROUPSET Shimano Ultegra 8020 disc 11v	PEDALI / PEDALS Shimano PDM520	SELLA / SADDLE Selle Italia XLR	REGGISELLA / SEAT POST FSA Gossamer	ATTACCO / STEM FSA OS 168 17°
CURVA / HANDLEBAR FSA Adventure	RUOTE / WHEELS Mavic Aksyum Allroad	COPERTURE / TIRES Challenge Gravel	P/BORRACCIA / BOTTLE CAGE Elite	



Code

BR02

Shimano 105 7000 disc 11v



GRUPPO / GROUPSET	PEDALI / PEDALS	SELLA / SADDLE	REGGISELLA / SEAT POST	ATTACCO / STEM
Shimano 105 7000 disc 11v	Shimano PDM520	Selle Italia XLR	FSA Gossamer	FSA OS 168 17°
CURVA / HANDLEBAR	RUOTE / WHEELS	COPERTURE / TIRES	P/BORRACCIA / BOTTLE CAGE	
FSA Adventure	Mavic Aksyum Allroad	Challenge Gravel	Elite	

Code

BR03

Sram Rival 1



GRUPPO / GROUPSET	PEDALI / PEDALS	SELLA / SADDLE	REGGISELLA / SEAT POST	ATTACCO / STEM
Sram Rival 1	Shimano PDM520	Selle Italia XLR	FSA Gossamer	FSA OS 168 17°
CURVA / HANDLEBAR	RUOTE / WHEELS	COPERTURE / TIRES	P/BORRACCIA / BOTTLE CAGE	
FSA Adventure	Mavic Aksyum Allroad	Challenge Gravel	Elite	

EUREKA TT

Corsa contro il tempo.

Eureka TT è la naturale evoluzione crono del modello Eureka Air. Testata e sviluppata in galleria del vento con i gli specialisti del team Bardiani-CSF, questa bicicletta rappresenta il segreto delle loro incredibili prestazioni a cronometro.

Eureka TT è il prodotto giusto per limare i secondi, grazie a un telaio estremamente leggero ma che siamo riusciti a mantenere rigido. Il setting profondamente aerodinamico di Eureka TT è completato dal sistema di attacco e curva integrato.

A timetrial machine.

Eureka TT is Eureka Air's timetrial evolution. Developed and tested in the wind tunnel together with the Bardiani-CSF team's specialists, this bicycle is the secret weapon of their incredible timetrial performances.

Eureka TT is the right product to erode the seconds, thanks to an extremely light frame which was maintained stiff enough. Eureka TT's aerodynamic setting is completed by the integrated stem.



TELAIO

Per la produzione di Eureka TT viene utilizzata solo fibra di alta qualità. Il carbonio in altissimo modulo viene utilizzato soprattutto nei vincoli di torsione massima come quelli del carro posteriore e della scatola movimento. Eureka TT è disponibile in ben cinque taglie, per dare la possibilità a chiunque di ottenere la posizione in sella migliore.

FRAME

Only high quality carbon fiber are used for the production of Eureka TT. The high-carbon fiber is used mainly in the maximum torsion constraints such as those of rear stay and the BB shell. Eureka TT is available in five sizes to give everyone the best riding position.



Code

EUTT01

Shimano Dura-ace 9100 TT

PESO TELAIO / FRAME WEIGHT : Kg 1,390

FORCELLA / FORK : Monocoque

SERIE STERZO / AHEADSET : a spessore differenziati / oversize 1-1/8 - 1-1/2

SCATOLA MOVIMENTO / BB SHELL : BSA

LIMITE DI PESO / WEIGHT LIMIT : 110 kg

PREDISPOSTO PER / PREPARED FOR : gruppi elettronici / electronic groups

Telaio incluso di freni a tiraggio diretto, attacco e curva manubrio con protesi
Frameset included of direct mount brakes, stem and handlebar with extensions

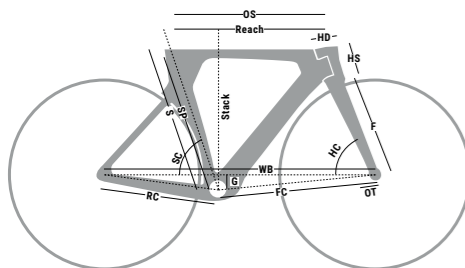

Misure	S	SP	SC	O	OS	HS	HC	F	OT	WB	FC	RC	G	HD	HB	ST	Stack	Reach
GEOMETRIE TELAIO EUREKA TT																		
XS	450	435	75	490	488	91,5	71	370	45	945,5	562,5	395	75	46	46	75	453,5	372,5
S	515	500	75	511	511,5	101,5	72,5	370	45	945,5	562,8	395	75	46	46	75	512	378
M	525	510	75	531,5	532	111,5	72,5	370	45	967	584	395	75	46	46	75	521,5	396
L	542	527	75	550,5	551	129,5	72,5	370	45	986,5	603,5	395	75	46	46	75	538	410
XL	561	546	75	569	569,5	148	72,5	370	45	1006	622,5	395	75	46	46	75	556	424

GRUPPO / GROUPSET	PEDALI / PEDALS	SELLA / SADDLE	REGGISELLA / SEAT POST	ATTACCO / STEM
Shimano Dura-ace 9100 TT	Look Keo Blade	Selle Italia Iron Flow	Eureka TT	Eureka TT
LEVE / GEAR LEVEL	RUOTE / WHEELS	COPERTURE / TIRES	P/BORRACCIA / BOTTLE CAGE	
Metron TT	Ant: Ursus TS87	Tubolari Vittoria Corsa graphene	Elite	
FRENI / BRAKES	Post: Ursus Gauro	CURVA / HANDLEBAR		
TRP		TEC for Eureka TT		

Code

EUTT02 BARDIANI 2019

Campagnolo Super Record 12v



GRUPPO / GROUPSET	PEDALI / PEDALS	SELLA / SADDLE	REGGISELLA / SEAT POST	ATTACCO / STEM
Campagnolo Super Record 12v	Look Keo Blade Crmo	Selle Italia Iron Flow	Eureka TT	Eureka TT
LEVE / GEAR LEVEL	RUOTE / WHEELS	COPERTURE / TIRES	P/BORRACCIA / BOTTLE CAGE	
Metron TT	Ant: Ursus Miura TS87	Tubolari Vittoria Corsa graphene	Elite	
FRENI / BRAKES	Post: Ursus Gauro	CURVA / HANDLEBAR		
TRP		TEC for Eureka TT		



EUREKA 70.3

La tua sfida definitiva.

Dedizione assoluta e preparazione maniacale: questo è il percorso che ti porta ad affrontare un Iron Man. Quel giorno dovrai superare te stesso prima ancora che i tuoi avversari, perciò è fondamentale curare ogni dettaglio.

Con questa filosofia abbiamo creato Eureka 70.3, un concentrato di tecnologia aerodinamica che la rende il prodotto ideale per raggiungere alte velocità, senza risentire del vento laterale. Scopri anche tutti i particolarissimi riflessi della speciale verniciatura "Camaleonte", che cambia colore con il sole. Un dettaglio di stile per chi desidera una bicicletta assolutamente accattivante.

Your ultimate challenge.

Absolute dedication and maniacal training sessions: that's the path that brings you to face an Iron Man. That day you'll need to overcome your limits before overcoming your opponents, that's why you have to sharpen the edges.

With this philosophy we've created Eureka 70.3, a mix of technology and aerodynamic setting that makes it the ideal product for reaching the highest speed without bearing the crosswind. Discover also the particular reflexes of the new "Chameleon" painting, which changes its color under the sun. A prestigious detail for those who want an eye-catching bike.

Misure	S	SC	O	HS	HC	F	OT	WB	FC	RC	G	Stack	Reach
GEOMETRIE TELAIO EUREKA 70.3													
XS	505	77	480	100	70,3	370	45	954,3	570,5	395	72	499,2	364,8
S	525	77	505	115	71,5	370	45	970,4	586,5	395	72	517,7	385,5
M	549	77	530	140	72	370	45	993,3	609,2	395	72	543,1	404,6
L	577	77	560	165	72,5	370	45	1020,8	636,5	395	72	568,7	428,7
XL	600	77	585	190	72,5	370	45	1048	663,5	395	72	592,6	448

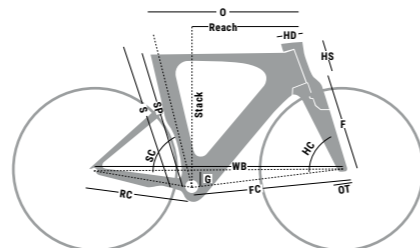

AN INTEGRATED SYSTEM

Il telaio di Eureka 70.3 comprende un kit con attacco, curva e protesi per poter offrire un sistema completo.

UN SISTEMA INTEGRATO

The frame of Eureka 70.3 includes a kit with stem, handlebar and extension in order to offer a complete system.



PORTA BARRETTE

Una importante novità tecnica è rappresentata dall'introduzione di un pratico porta barrette energetiche, facilmente removibile.

ENERGY BAR BOX

An important technical innovation is the introduction of a practical energy bar box, easily removable.



PESO TELAIO / FRAME WEIGHT : Kg 1,500

FORCELLA / FORK : Monocoque

REGGISELLA / SEAT POST : Eureka 70.3

SERIE STERZO / AHEADSET : a spessore differenziati / oversize 1-1/8 - 1-1/2

SCATOLA MOVIMENTO / BB SHELL : Pressfit

LIMITE DI PESO / WEIGHT LIMIT : 120 kg

PREDISPOSTO PER / PREPARED FOR : gruppi elettronici / electronic groups

Telaio incluso di freni a tiraggio diretto, attacco e curva manubrio con protesi

Frameset included of direct mount brakes, stem and handlebar with extensions

Code EU70-01

Shimano Ultegra 8050 11v



GRUPPO / GROUPSET	PEDALI / PEDALS	SELLA / SADDLE	REGGISELLA / SEAT POST	ATTACCO / STEM
Shimano Ultegra 8050 11v	Look Keo 2 max	Selle Italia Iron Flow	Eureka TT	Eureka TT
LEVE / GEAR LEVEL	RUOTE / WHEELS	COPERTURE / TIRES	P/BORRACCIA / BOTTLE CAGE	
Metron TT	Ursus Miura TS87	Tubolari Vittoria Corsa Graphene	Elite	
FRENI / BRAKES	CURVA / HANDLEBAR			
TRP	TEC for Eureka TT			

Code EU70-02

Shimano Ultegra 8000 11v



GRUPPO / GROUPSET	PEDALI / PEDALS	SELLA / SADDLE	REGGISELLA / SEAT POST	ATTACCO / STEM
Shimano Ultegra 8000 11v	Look Keo 2 max	Selle Italia Iron Flow	Eureka TT	Eureka TT
LEVE / GEAR LEVEL	RUOTE / WHEELS	COPERTURE / TIRES	P/BORRACCIA / BOTTLE CAGE	
Metron TT	Ursus Miura TS87	Tubolari Vittoria Corsa graphene	Elite	
FRENI / BRAKES	CURVA / HANDLEBAR			
TRP	TEC for Eureka TT			



WIND

Code
WIND

Shimano 105 7000 11v

- PESO TELAIO / FRAME WEIGHT :** Kg 1,300
- FORCELLA / FORK :** Full Carbon
- REGGISELLA / SEAT POST :** Wind
- SERIE STERZO / AHEADSET :** a spessore differenziati / oversize 1-1/8 - 1-1/2
- SCATOLA MOVIMENTO / BB SHELL :** Pressfit
- LIMITE DI PESO / WEIGHT LIMIT :** 120 kg
- PREDISPOSTO PER / PREPARED FOR :** gruppi elettronici / electronic groups
- Telaio incluso di freni a tiraggio diretto e attacco manubrio**
Frameset included of direct mount brakes and stem

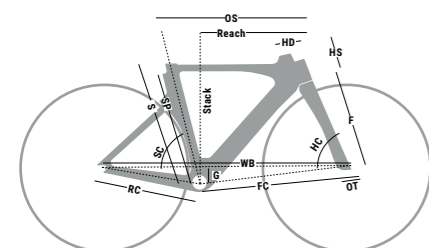

Misure	S	SP	SC	O	OS	HS	HC	F	OT	WB	FC	RC	G	Reach	Stack
GEOMETRIE SLOPING TELAIO WIND															
S	500	480,6	76	517,3	519,2	90	72	368	43	966,7	581,2	396	70	394,5	492,2
M	520	502,7	76	537,5	539,3	115	73	368	43	980,1	594,5	396	70	408,1	519,3
L	540	523	76	557,5	559,3	135,5	73	368	43	1001,2	615,4	396	70	423,4	538,4

GRUPPO / GROUPSET Shimano 105 7000 11v	PEDALI / PEDALS Look Keo Classic	SELLA / SADDLE Selle Italia X3 Boost	REGGISELLA / SEAT POST Wind	ATTACCO / STEM Wind
LEVE / GEAR LEVEL Metron TT	RUOTE / WHEELS Ant: Ursus Miura TS87	COPERTURE / TIRES Tubolari Vittoria Rubino Graphene	P/BORRACCIA / BOTTLE CAGE Elite	
FRENI / BRAKES TRP	Post: Ursus Gauro	CURVA / HANDLEBAR Wind		

CYKELN FIXED

Adrenalina e Criterium: ecco Fixed.

Guerciotti entra ufficialmente nel mondo ad una velocità e lo fa con stile. Dalla collaborazione con il team CykelN Divisione Corse è stata sviluppata CykelN Fixed, bici ufficiale di una delle squadre più forti in assoluto nel circuito Red Hook.

CykelN Fixed è un prodotto di alta gamma assolutamente trasversale: è disponibile infatti con montaggio Track, per dare il massimo in velodromo, oppure con setting puramente fixed, per esprimere il meglio negli appuntamenti Criterium.

Adrenaline and Criterium: introducing Fixed.

Guerciotti enters the fixed world in style. CykelN Fixed, the official bike of one of the strongest teams in the Red Hook circuit, has been developed in collaboration with the CykelN Divisione Corse team.

CykelN Fixed is a high-end product that is absolutely transversal: it is available with Track assembly, to give all in the velodrome, or with a purely fixed setting, to express your best in Criterium events.



Code
**CYKELN
FIXED CRITERIUM**

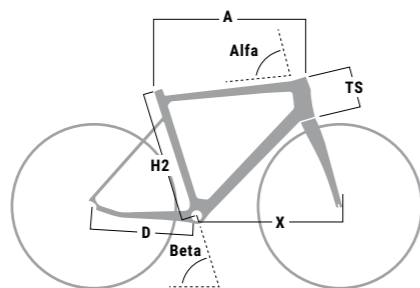

Misure	H2	A	X	D	TS	Beta	Alfa
GEOMETRIE SLOPING TELAIO CYKELN							
480	480	508,8	561,9	390	100	75°	73°
500	500	518,2	553,9	390	120	74°	74°
520	520	538,7	574,4	390	140	74°	74°
530	530	561,2	596,8	390	160	74°	74°
560	560	577,7	613,3	390	180	74°	74°
590	590	588	623,5	390	210	74°	74°



TUBAZIONI / PIPES : alluminio Dedacciai / alloy Dedacciai
FORCELLA / FORK : Monocoque Dedacciai Black Stream
SERIE STERZO / AHEADSET : a spessore differenziati / oversize 1-1/8 - 1-1/2
SCATOLA MOVIMENTO / BB SHELL : BSA
REGGISELLA / SEAT POST : 27.2
LIMITE DI PESO / WEIGHT LIMIT : 120 kg

GUARNITURA	PEDALI / PEDALS	SELLA / SADDLE	REGGISELLA / SEAT POST	ATTACCO / STEM
Miche Pistard Air	Look Keo classic	Selle italia SLS	Dedaelementi Zero 100	Dedaelementi Super Zero
CURVA / HANDLEBAR	RUOTE / WHEELS	COPERTURE / TIRES	P/BORRACCIA / BOTTLE CAGE	
Dedaelementi Super Zero Alloy	Ant: Miche Supertype pista 50 Post: Miche Supertype pista 88	Tubolari Vittoria Rubino Graphene	-	

Code
**CYKELN
TRACK**



GUARNITURA	PEDALI / PEDALS	SELLA / SADDLE	REGGISELLA / SEAT POST	ATTACCO / STEM
Miche Pistard	Look Keo classic	Selle italia SLS	Dedaelementi Zero 100	Dedaelementi Pista
CURVA / HANDLEBAR	RUOTE / WHEELS	COPERTURE / TIRES	P/BORRACCIA / BOTTLE CAGE	
Dedaelementi Zero pista	Miche Pistard	Tubolari Vittoria Rubino Graphene	-	





GUERCIOTTI

Guerciotti Export Srl si riserva il diritto di apportare tutte le modifiche che si rendessero opportune o necessarie al miglioramento del prodotto senza darne alcun preavviso. Tutti i diritti sono riservati.

Guerciotti Export Srl reserves the right to make all modifications that may be appropriate or necessary to improve its products, without any prior notice. All rights reserved.

THE BRIGHTEST STAR IN MILAN

Concept: Albertdesign.net
Photo by: Albertdesign & ©BettiniPhoto



GUERCIOTTI

GUERCIOTTI EXPORT Srl

Via Petrocchi, 10
20127 Milano - Italia

TEL +39 02 2826188
FAX +39 02 26826954

GUERCIOTTI.IT